

Verification Report

No. CANEC1208978801

Date: 10 Aug 2012

Page 1 of 40

FUYUAN ELECTRONIC CO.,LTD

XIEWU VILLAGE,HENGSHAN,SHIPAI TOWN,DEPARTMENT DONGGUAN,GUANGDONG,CHINA

Sample Name : AC Switching adaptor
SGS Job No. : CP12-032207 - SZ
Tested Basic Model No. FYXXXXYYYY
(P.O. No.) :
Date of Sample Received : 06 Jul 2012
Verification Period : 06 Jul 2012 - 10 Aug 2012
Verification Requested : With reference to RoHS Directive 2011/65/EU recasting 2002/95/EC.
Verification Method : Please refer to next page(s).
Verification Result : Please refer to next page(s).
Verification Conclusion : Based on the review of previous reports and verification results of the submitted samples, the results of Cadmium, Lead, Mercury, Hexavalent chromium, Polybrominated biphenyls (PBBs), Polybrominated diphenyl ethers (PBDEs) comply with the limits as set by RoHS Directive 2011/65/EU recasting 2002/95/EC.
Note : The test results are related only to the tested items. The report shall not be reproduced except in full without the written approval of the testing laboratory.

Signed for and on behalf of
SGS-CSTC Ltd.

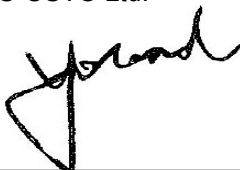

Yolanda Yan

Approved Signatory

This document is issued by the Company subject to its General Conditions of Service printed overleaf, available on request or accessible at http://www.sgs.com/terms_and_conditions.htm and, for electronic format documents, subject to Terms and Conditions for Electronic Documents at www.sgs.com/terms_e-document.htm. Attention is drawn to the limitation of liability, indemnification and jurisdiction issues defined therein. Any holder of this document is advised that information contained hereon reflects the Company's findings at the time of its preparation only, and within the limits of Client's instructions, if any. The Company's sole responsibility is to its Client and this document does not exonerate parties to a transaction from exercising all their rights and obligations under the transaction documents. This document cannot be reproduced except in full, without prior written approval of the Company. Any unauthorized alteration, forgery or falsification of the content or appearance of this document is unlawful and offenders may be prosecuted to the fullest extent of the law. Unless otherwise stated, the results shown in this test report refer only to the sample(s) tested.

Verification Report

No. CANEC1208978801

Date: 10 Aug 2012

Page 2 of 40

Verification Method :

1. Review was performed for the samples disjointed from the submitted articles and the related test reports submitted by the Applicant
2. Tests were performed for the samples indicated by the photos in the report with test methods reference to IEC 62321:2008: Procedures for the Determination of Levels of Six Regulated Substances in Electrotechnical Products
 - (1) Screening by XRF Spectroscopy
 - (2) Wet Chemical Test Method
 - a. Determination of Lead & Cadmium by ICP-OES or AAS
 - b. Determination of Mercury by ICP-OES
 - c. Determination of Hexavalent Chromium by Spot test or Colorimetric Method
 - d. Determination of PBBs and PBDEs by GC-MS

This document is issued by the Company subject to its General Conditions of Service printed overleaf, available on request or accessible at http://www.sgs.com/terms_and_conditions.htm and, for electronic format documents, subject to Terms and Conditions for Electronic Documents at www.sgs.com/terms_e-document.htm. Attention is drawn to the limitation of liability, indemnification and jurisdiction issues defined therein. Any holder of this document is advised that information contained hereon reflects the Company's findings at the time of its preparation only and within the limits of Client's instructions, if any. The Company's sole responsibility is to its Client and this document does not exonerate parties to a transaction from exercising all their rights and obligations under the transaction documents. This document cannot be reproduced except in full, without prior written approval of the Company. Any unauthorized alteration, forgery or falsification of the content or appearance of this document is unlawful and offenders may be prosecuted to the fullest extent of the law. Unless otherwise stated, the results shown in this test report refer only to the sample(s) tested.

Part No.	Part Description	BOM No.	Restricted Substances	Results of EDXRF (1)	Result of Wet Chemical Testing(2) (mg/kg)	Conclusion on RoHS	Sample Submitted / Resubmitted Date
1	Black plastic shell		Pb Cd Hg Cr(VI) PBBs PBDEs	BL BL BL BL IN IN	--- --- --- --- ND 17	Comply Comply Comply Comply Comply Comply	06 Jul 2012
2	Black plastic (SR) (on No.1)		Pb Cd Hg Cr(VI) PBBs PBDEs	BL BL BL BL BL BL	--- --- --- --- --- ---	Comply Comply Comply Comply Comply Comply	06 Jul 2012
3	Black plastic w/ white printing (wire insulation) (connected w/ No.1)		Pb Cd Hg Cr(VI) PBBs PBDEs	BL BL BL BL BL BL	--- --- --- --- --- ---	Comply Comply Comply Comply Comply Comply	06 Jul 2012
4	Black plastic tie (on No.3)		Pb Cd Hg Cr(VI) PBBs PBDEs	BL BL BL BL BL BL	--- --- --- --- --- ---	Comply Comply Comply Comply Comply Comply	06 Jul 2012

This document is issued by the Company subject to its General Conditions of Service printed overleaf, available on request or accessible at http://www.sgs.com/terms_and_conditions.htm and, for electronic format documents, subject to Terms and Conditions for Electronic Documents at www.sgs.com/terms_e-document.htm. Attention is drawn to the limitation of liability, indemnification and jurisdiction issues defined therein. Any holder of this document is advised that information contained hereon reflects the Company's findings at the time of its preparation only and within the limits of Client's instructions, if any. The Company's sole responsibility is to its Client and this document does not exonerate parties to a transaction from exercising all their rights and obligations under the transaction documents. This document cannot be reproduced except in full, without prior written approval of the Company. Any unauthorized alteration, forgery or falsification of the content or appearance of this document is unlawful and offenders may be prosecuted to the fullest extent of the law. Unless otherwise stated, the results shown in this test report refer only to the sample(s) tested.

Part No.	Part Description	BOM No.	Restricted Substances	Results of EDXRF (1)	Result of Wet Chemical Testing(2) (mg/kg)	Conclusion on RoHS	Sample Submitted / Resubmitted Date
5	Silvery metal wire (in No.4)		Pb Cd Hg Cr(VI) PBBs PBDEs	BL BL BL BL --- ---	--- --- --- --- --- ---	Comply Comply Comply Comply --- ---	06 Jul 2012
6	Black plastic shell (on No.3)		Pb Cd Hg Cr(VI) PBBs PBDEs	BL BL BL BL BL BL	--- --- --- --- --- ---	Comply Comply Comply Comply Comply Comply	06 Jul 2012
7	Silvery metal tube (on No.6)		Pb Cd Hg Cr(VI) PBBs PBDEs	BL BL BL BL --- ---	--- --- --- --- --- ---	Comply Comply Comply Comply --- ---	06 Jul 2012
8	Copper-colored metal wire (in No.3)		Pb Cd Hg Cr(VI) PBBs PBDEs	BL BL BL BL --- ---	--- --- --- --- --- ---	Comply Comply Comply Comply --- ---	06 Jul 2012

This document is issued by the Company subject to its General Conditions of Service printed overleaf, available on request or accessible at http://www.sgs.com/terms_and_conditions.htm and, for electronic format documents, subject to Terms and Conditions for Electronic Documents at www.sgs.com/terms_e-document.htm. Attention is drawn to the limitation of liability, indemnification and jurisdiction issues defined therein. Any holder of this document is advised that information contained hereon reflects the Company's findings at the time of its preparation only and within the limits of Client's instructions, if any. The Company's sole responsibility is to its Client and this document does not exonerate parties to a transaction from exercising all their rights and obligations under the transaction documents. This document cannot be reproduced except in full, without prior written approval of the Company. Any unauthorized alteration, forgery or falsification of the content or appearance of this document is unlawful and offenders may be prosecuted to the fullest extent of the law. Unless otherwise stated, the results shown in this test report refer only to the sample(s) tested.

Part No.	Part Description	BOM No.	Restricted Substances	Results of EDXRF (1)	Result of Wet Chemical Testing(2) (mg/kg)	Conclusion on RoHS	Sample Submitted / Resubmitted Date
9	Black plastic tube (in No.7)		Pb	BL	---	Comply	06 Jul 2012
			Cd	BL	---	Comply	
			Hg	BL	---	Comply	
			Cr(VI)	BL	---	Comply	
			PBBs	BL	---	Comply	
			PBDEs	BL	---	Comply	
10	Silvery metal (solder) (on No.7)		Pb	BL	---	Comply	06 Jul 2012
			Cd	BL	---	Comply	
			Hg	BL	---	Comply	
			Cr(VI)	BL	---	Comply	
			PBBs	---	---	---	
			PBDEs	---	---	---	
11	Silvery metal sheet (in No.9)		Pb	BL	---	Comply	06 Jul 2012
			Cd	BL	---	Comply	
			Hg	BL	---	Comply	
			Cr(VI)	BL	---	Comply	
			PBBs	---	---	---	
			PBDEs	---	---	---	
12	Transparent plastic part (in No.1)		Pb	BL	---	Comply	06 Jul 2012
			Cd	BL	---	Comply	
			Hg	BL	---	Comply	
			Cr(VI)	BL	---	Comply	
			PBBs	BL	---	Comply	
			PBDEs	BL	---	Comply	

This document is issued by the Company subject to its General Conditions of Service printed overleaf, available on request or accessible at http://www.sgs.com/terms_and_conditions.htm and, for electronic format documents, subject to Terms and Conditions for Electronic Documents at www.sgs.com/terms_e-document.htm. Attention is drawn to the limitation of liability, indemnification and jurisdiction issues defined therein. Any holder of this document is advised that information contained hereon reflects the Company's findings at the time of its preparation only and within the limits of Client's instructions, if any. The Company's sole responsibility is to its Client and this document does not exonerate parties to a transaction from exercising all their rights and obligations under the transaction documents. This document cannot be reproduced except in full, without prior written approval of the Company. Any unauthorized alteration, forgery or falsification of the content or appearance of this document is unlawful and offenders may be prosecuted to the fullest extent of the law. Unless otherwise stated, the results shown in this test report refer only to the sample(s) tested.

Part No.	Part Description	BOM No.	Restricted Substances	Results of EDXRF (1)	Result of Wet Chemical Testing(2) (mg/kg)	Conclusion on RoHS	Sample Submitted / Resubmitted Date
13	Green "PCB" (in No.1)		Pb Cd Hg Cr(VI) PBBs PBDEs	BL BL BL BL IN IN	--- --- --- --- ND ND	Comply Comply Comply Comply Comply Comply	06 Jul 2012
14	Silvery metal sheet (on No.13)		Pb Cd Hg Cr(VI) PBBs PBDEs	BL BL BL BL --- ---	--- --- --- --- --- ---	Comply Comply Comply Comply --- ---	06 Jul 2012
15	Blue adhesive plastic tape (on No.14)		Pb Cd Hg Cr(VI) PBBs PBDEs	BL BL BL BL BL BL	--- --- --- --- --- ---	Comply Comply Comply Comply Comply Comply	06 Jul 2012
16	Silvery metal shell w/ black printing (on No.13)		Pb Cd Hg Cr(VI) PBBs PBDEs	BL BL BL BL --- ---	--- --- --- --- --- ---	Comply Comply Comply Comply --- ---	06 Jul 2012

This document is issued by the Company subject to its General Conditions of Service printed overleaf, available on request or accessible at http://www.sgs.com/terms_and_conditions.htm and, for electronic format documents, subject to Terms and Conditions for Electronic Documents at www.sgs.com/terms_e-document.htm. Attention is drawn to the limitation of liability, indemnification and jurisdiction issues defined therein. Any holder of this document is advised that information contained hereon reflects the Company's findings at the time of its preparation only and within the limits of Client's instructions, if any. The Company's sole responsibility is to its Client and this document does not exonerate parties to a transaction from exercising all their rights and obligations under the transaction documents. This document cannot be reproduced except in full, without prior written approval of the Company. Any unauthorized alteration, forgery or falsification of the content or appearance of this document is unlawful and offenders may be prosecuted to the fullest extent of the law. Unless otherwise stated, the results shown in this test report refer only to the sample(s) tested.

Part No.	Part Description	BOM No.	Restricted Substances	Results of EDXRF (1)	Result of Wet Chemical Testing(2) (mg/kg)	Conclusion on RoHS	Sample Submitted / Resubmitted Date
17	Black body w/ brown printing (on No.14)		Pb Cd Hg Cr(VI) PBBs PBDEs	BL BL BL BL IN IN	--- --- --- --- ND ND	Comply Comply Comply Comply Comply Comply	06 Jul 2012
18	Silvery metal pin (on No.17)		Pb Cd Hg Cr(VI) PBBs PBDEs	BL BL BL BL --- ---	--- --- --- --- --- ---	Comply Comply Comply Comply --- ---	06 Jul 2012
19	Dk-grey core (on No.18)		Pb Cd Hg Cr(VI) PBBs PBDEs	BL BL BL BL BL BL	--- --- --- --- --- ---	Comply Comply Comply Comply Comply Comply	06 Jul 2012
20	Silvery metal pin (on No.14)		Pb Cd Hg Cr(VI) PBBs PBDEs	BL BL BL BL --- ---	--- --- --- --- --- ---	Comply Comply Comply Comply --- ---	06 Jul 2012

This document is issued by the Company subject to its General Conditions of Service printed overleaf, available on request or accessible at http://www.sgs.com/terms_and_conditions.htm and, for electronic format documents, subject to Terms and Conditions for Electronic Documents at www.sgs.com/terms_e-document.htm. Attention is drawn to the limitation of liability, indemnification and jurisdiction issues defined therein. Any holder of this document is advised that information contained hereon reflects the Company's findings at the time of its preparation only and within the limits of Client's instructions, if any. The Company's sole responsibility is to its Client and this document does not exonerate parties to a transaction from exercising all their rights and obligations under the transaction documents. This document cannot be reproduced except in full, without prior written approval of the Company. Any unauthorized alteration, forgery or falsification of the content or appearance of this document is unlawful and offenders may be prosecuted to the fullest extent of the law. Unless otherwise stated, the results shown in this test report refer only to the sample(s) tested.

Part No.	Part Description	BOM No.	Restricted Substances	Results of EDXRF (1)	Result of Wet Chemical Testing(2) (mg/kg)	Conclusion on RoHS	Sample Submitted / Resubmitted Date
21	Silvery metal nut (on No.17)		Pb Cd Hg Cr(VI) PBBs PBDEs	BL BL BL BL --- ---	--- --- --- --- --- ---	Comply Comply Comply Comply --- ---	06 Jul 2012
22	Silvery metal screw (on No.21)		Pb Cd Hg Cr(VI) PBBs PBDEs	BL BL BL BL --- ---	--- --- --- --- --- ---	Comply Comply Comply Comply --- ---	06 Jul 2012
23	Black body w/ brown printing (in No.16)		Pb Cd Hg Cr(VI) PBBs PBDEs	BL BL BL BL BL BL	--- --- --- --- --- ---	Comply Comply Comply Comply Comply Comply	06 Jul 2012
24	Grey metal pin (on No.23)		Pb Cd Hg Cr(VI) PBBs PBDEs	BL BL BL BL --- ---	--- --- --- --- --- ---	Comply Comply Comply Comply --- ---	06 Jul 2012

This document is issued by the Company subject to its General Conditions of Service printed overleaf, available on request or accessible at http://www.sgs.com/terms_and_conditions.htm and, for electronic format documents, subject to Terms and Conditions for Electronic Documents at www.sgs.com/terms_e-document.htm. Attention is drawn to the limitation of liability, indemnification and jurisdiction issues defined therein. Any holder of this document is advised that information contained hereon reflects the Company's findings at the time of its preparation only and within the limits of Client's instructions, if any. The Company's sole responsibility is to its Client and this document does not exonerate parties to a transaction from exercising all their rights and obligations under the transaction documents. This document cannot be reproduced except in full, without prior written approval of the Company. Any unauthorized alteration, forgery or falsification of the content or appearance of this document is unlawful and offenders may be prosecuted to the fullest extent of the law. Unless otherwise stated, the results shown in this test report refer only to the sample(s) tested.

Part No.	Part Description	BOM No.	Restricted Substances	Results of EDXRF (1)	Result of Wet Chemical Testing(2) (mg/kg)	Conclusion on RoHS	Sample Submitted / Resubmitted Date
25 -C	Black plastic w/ golden printing (outer shell) (C17 on No.13)		Pb	BL	---	Comply	06 Jul 2012 26 Jul 2012
			Cd	BL	---	Comply	
			Hg	BL	---	Comply	
			Cr(VI)	BL	---	Comply	
			PBBs	BL	---	Comply	
			PBDEs	BL	---	Comply	
26	Dk-grey core (PT1 on No.13)		Pb	BL	---	Comply	06 Jul 2012
			Cd	BL	---	Comply	
			Hg	BL	---	Comply	
			Cr(VI)	BL	---	Comply	
			PBBs	BL	---	Comply	
			PBDEs	BL	---	Comply	
27	Black plastic w/ white printing (outer shell) (C8 on No.13)		Pb	BL	---	Comply	06 Jul 2012
			Cd	BL	---	Comply	
			Hg	BL	---	Comply	
			Cr(VI)	BL	---	Comply	
			PBBs	BL	---	Comply	
			PBDEs	BL	---	Comply	
28	Black body w/ brown printing (BG1 on No.13)		Pb	BL	---	Comply	06 Jul 2012
			Cd	BL	---	Comply	
			Hg	BL	---	Comply	
			Cr(VI)	BL	---	Comply	
			PBBs	IN	ND	Comply	
			PBDEs	IN	ND	Comply	

This document is issued by the Company subject to its General Conditions of Service printed overleaf, available on request or accessible at http://www.sgs.com/terms_and_conditions.htm and, for electronic format documents, subject to Terms and Conditions for Electronic Documents at www.sgs.com/terms_e-document.htm. Attention is drawn to the limitation of liability, indemnification and jurisdiction issues defined therein. Any holder of this document is advised that information contained hereon reflects the Company's findings at the time of its preparation only and within the limits of Client's instructions, if any. The Company's sole responsibility is to its Client and this document does not exonerate parties to a transaction from exercising all their rights and obligations under the transaction documents. This document cannot be reproduced except in full, without prior written approval of the Company. Any unauthorized alteration, forgery or falsification of the content or appearance of this document is unlawful and offenders may be prosecuted to the fullest extent of the law. Unless otherwise stated, the results shown in this test report refer only to the sample(s) tested.

Part No.	Part Description	BOM No.	Restricted Substances	Results of EDXRF (1)	Result of Wet Chemical Testing(2) (mg/kg)	Conclusion on RoHS	Sample Submitted / Resubmitted Date
29	Yellow plastic shell w/ black printing (C1 on No.13)		Pb	BL	---	Comply	06 Jul 2012
			Cd	BL	---	Comply	
			Hg	BL	---	Comply	
			Cr(VI)	BL	---	Comply	
			PBBs	IN	ND	Comply	
			PBDEs	IN	ND	Comply	
30	Black plastic shell (J1 on No.13)		Pb	BL	---	Comply	06 Jul 2012
			Cd	BL	---	Comply	
			Hg	BL	---	Comply	
			Cr(VI)	BL	---	Comply	
			PBBs	BL	---	Comply	
			PBDEs	BL	---	Comply	
31	Black body w/ white printing (NTC1 on No.13)		Pb	BL	---	Comply	06 Jul 2012
			Cd	BL	---	Comply	
			Hg	BL	---	Comply	
			Cr(VI)	BL	---	Comply	
			PBBs	BL	---	Comply	
			PBDEs	BL	---	Comply	
32 -C	Black plastic w/ white printing (heat shrinkable tube) (R6 on No.13)		Pb	BL	---	Comply	06 Jul 2012 26 Jul 2012
			Cd	BL	---	Comply	
			Hg	BL	---	Comply	
			Cr(VI)	BL	---	Comply	
			PBBs	BL	---	Comply	
			PBDEs	BL	---	Comply	

This document is issued by the Company subject to its General Conditions of Service printed overleaf, available on request or accessible at http://www.sgs.com/terms_and_conditions.htm and, for electronic format documents, subject to Terms and Conditions for Electronic Documents at www.sgs.com/terms_e-document.htm. Attention is drawn to the limitation of liability, indemnification and jurisdiction issues defined therein. Any holder of this document is advised that information contained hereon reflects the Company's findings at the time of its preparation only and within the limits of Client's instructions, if any. The Company's sole responsibility is to its Client and this document does not exonerate parties to a transaction from exercising all their rights and obligations under the transaction documents. This document cannot be reproduced except in full, without prior written approval of the Company. Any unauthorized alteration, forgery or falsification of the content or appearance of this document is unlawful and offenders may be prosecuted to the fullest extent of the law. Unless otherwise stated, the results shown in this test report refer only to the sample(s) tested.

Part No.	Part Description	BOM No.	Restricted Substances	Results of EDXRF (1)	Result of Wet Chemical Testing(2) (mg/kg)	Conclusion on RoHS	Sample Submitted / Resubmitted Date
33	Blue body w/ brown printing (C13 on No.13)		Pb	BL	---	Comply	06 Jul 2012
			Cd	BL	---	Comply	
			Hg	BL	---	Comply	
			Cr(VI)	BL	---	Comply	
			PBBs	BL	---	Comply	
			PBDEs	BL	---	Comply	
34	Black body w/ brown printing (IC4 on No.13)		Pb	BL	---	Comply	06 Jul 2012
			Cd	BL	---	Comply	
			Hg	BL	---	Comply	
			Cr(VI)	BL	---	Comply	
			PBBs	IN	ND	Comply	
			PBDEs	IN	ND	Comply	
35	Silvery metal shell (in No.25)		Pb	BL	---	Comply	06 Jul 2012
			Cd	BL	---	Comply	
			Hg	BL	---	Comply	
			Cr(VI)	BL	---	Comply	
			PBBs	---	---	---	
			PBDEs	---	---	---	
36	Brown paper w/ liquid (in No.35)		Pb	BL	---	Comply	06 Jul 2012
			Cd	BL	---	Comply	
			Hg	BL	---	Comply	
			Cr(VI)	BL	---	Comply	
			PBBs	BL	---	Comply	
			PBDEs	BL	---	Comply	

This document is issued by the Company subject to its General Conditions of Service printed overleaf, available on request or accessible at http://www.sgs.com/terms_and_conditions.htm and, for electronic format documents, subject to Terms and Conditions for Electronic Documents at www.sgs.com/terms_e-document.htm. Attention is drawn to the limitation of liability, indemnification and jurisdiction issues defined therein. Any holder of this document is advised that information contained hereon reflects the Company's findings at the time of its preparation only and within the limits of Client's instructions, if any. The Company's sole responsibility is to its Client and this document does not exonerate parties to a transaction from exercising all their rights and obligations under the transaction documents. This document cannot be reproduced except in full, without prior written approval of the Company. Any unauthorized alteration, forgery or falsification of the content or appearance of this document is unlawful and offenders may be prosecuted to the fullest extent of the law. Unless otherwise stated, the results shown in this test report refer only to the sample(s) tested.

Part No.	Part Description	BOM No.	Restricted Substances	Results of EDXRF (1)	Result of Wet Chemical Testing(2) (mg/kg)	Conclusion on RoHS	Sample Submitted / Resubmitted Date
37	Silver-grey metal foil (in No.35)		Pb Cd Hg Cr(VI) PBBs PBDEs	BL BL BL BL --- ---	--- --- --- --- --- ---	Comply Comply Comply Comply --- ---	06 Jul 2012
38	Silvery metal pin (in No.35)		Pb Cd Hg Cr(VI) PBBs PBDEs	BL BL BL BL --- ---	--- --- --- --- --- ---	Comply Comply Comply Comply --- ---	06 Jul 2012
39	Black rubber (cover) (on No.35)		Pb Cd Hg Cr(VI) PBBs PBDEs	BL BL BL BL BL BL	--- --- --- --- --- ---	Comply Comply Comply Comply Comply Comply	06 Jul 2012
40	Black plastic bobbin (on No.26)		Pb Cd Hg Cr(VI) PBBs PBDEs	BL BL BL BL BL BL	--- --- --- --- --- ---	Comply Comply Comply Comply Comply Comply	06 Jul 2012

This document is issued by the Company subject to its General Conditions of Service printed overleaf, available on request or accessible at http://www.sgs.com/terms_and_conditions.htm and, for electronic format documents, subject to Terms and Conditions for Electronic Documents at www.sgs.com/terms_e-document.htm. Attention is drawn to the limitation of liability, indemnification and jurisdiction issues defined therein. Any holder of this document is advised that information contained hereon reflects the Company's findings at the time of its preparation only and within the limits of Client's instructions, if any. The Company's sole responsibility is to its Client and this document does not exonerate parties to a transaction from exercising all their rights and obligations under the transaction documents. This document cannot be reproduced except in full, without prior written approval of the Company. Any unauthorized alteration, forgery or falsification of the content or appearance of this document is unlawful and offenders may be prosecuted to the fullest extent of the law. Unless otherwise stated, the results shown in this test report refer only to the sample(s) tested.

Part No.	Part Description	BOM No.	Restricted Substances	Results of EDXRF (1)	Result of Wet Chemical Testing(2) (mg/kg)	Conclusion on RoHS	Sample Submitted / Resubmitted Date
41	Copper-colored metal wire w/ transparent surface (on No.40)		Pb Cd Hg Cr(VI) PBBs PBDEs	BL BL BL BL BL BL	--- --- --- --- --- ---	Comply Comply Comply Comply Comply Comply	06 Jul 2012
42	White translucent plastic tape (on No.40)		Pb Cd Hg Cr(VI) PBBs PBDEs	BL BL BL BL BL BL	--- --- --- --- --- ---	Comply Comply Comply Comply Comply Comply	06 Jul 2012
43	Transparent plastic tube (on No.40)		Pb Cd Hg Cr(VI) PBBs PBDEs	BL BL BL BL BL BL	--- --- --- --- --- ---	Comply Comply Comply Comply Comply Comply	06 Jul 2012
44	Yellow plastic (wire insulation) (in No.43)		Pb Cd Hg Cr(VI) PBBs PBDEs	BL BL BL BL BL BL	--- --- --- --- --- ---	Comply Comply Comply Comply Comply Comply	06 Jul 2012

This document is issued by the Company subject to its General Conditions of Service printed overleaf, available on request or accessible at http://www.sgs.com/terms_and_conditions.htm and, for electronic format documents, subject to Terms and Conditions for Electronic Documents at www.sgs.com/terms_e-document.htm. Attention is drawn to the limitation of liability, indemnification and jurisdiction issues defined therein. Any holder of this document is advised that information contained hereon reflects the Company's findings at the time of its preparation only and within the limits of Client's instructions, if any. The Company's sole responsibility is to its Client and this document does not exonerate parties to a transaction from exercising all their rights and obligations under the transaction documents. This document cannot be reproduced except in full, without prior written approval of the Company. Any unauthorized alteration, forgery or falsification of the content or appearance of this document is unlawful and offenders may be prosecuted to the fullest extent of the law. Unless otherwise stated, the results shown in this test report refer only to the sample(s) tested.

Part No.	Part Description	BOM No.	Restricted Substances	Results of EDXRF (1)	Result of Wet Chemical Testing(2) (mg/kg)	Conclusion on RoHS	Sample Submitted / Resubmitted Date
45	Copper-colored metal wire (in No.44)		Pb Cd Hg Cr(VI) PBBs PBDEs	BL BL BL BL --- ---	--- --- --- --- --- ---	Comply Comply Comply Comply --- ---	06 Jul 2012
46	Silvery block (in No.29)		Pb Cd Hg Cr(VI) PBBs PBDEs	BL BL BL BL BL BL	--- --- --- --- --- ---	Comply Comply Comply Comply Comply Comply	06 Jul 2012
47	Yellow block (envelopment) (in No.29)		Pb Cd Hg Cr(VI) PBBs PBDEs	BL BL BL BL BL BL	--- --- --- --- --- ---	Comply Comply Comply Comply Comply Comply	06 Jul 2012
48	Silvery metal pin (in No.29)		Pb Cd Hg Cr(VI) PBBs PBDEs	BL BL BL BL --- ---	--- --- --- --- --- ---	Comply Comply Comply Comply --- ---	06 Jul 2012

This document is issued by the Company subject to its General Conditions of Service printed overleaf, available on request or accessible at http://www.sgs.com/terms_and_conditions.htm and, for electronic format documents, subject to Terms and Conditions for Electronic Documents at www.sgs.com/terms_e-document.htm. Attention is drawn to the limitation of liability, indemnification and jurisdiction issues defined therein. Any holder of this document is advised that information contained hereon reflects the Company's findings at the time of its preparation only and within the limits of Client's instructions, if any. The Company's sole responsibility is to its Client and this document does not exonerate parties to a transaction from exercising all their rights and obligations under the transaction documents. This document cannot be reproduced except in full, without prior written approval of the Company. Any unauthorized alteration, forgery or falsification of the content or appearance of this document is unlawful and offenders may be prosecuted to the fullest extent of the law. Unless otherwise stated, the results shown in this test report refer only to the sample(s) tested.

Part No.	Part Description	BOM No.	Restricted Substances	Results of EDXRF (1)	Result of Wet Chemical Testing(2) (mg/kg)	Conclusion on RoHS	Sample Submitted / Resubmitted Date
49	Silvery metal pin (in No.29)		Pb	OL	16554▲	Comply	06 Jul 2012
			Cd	BL	---	Comply	
			Hg	BL	---	Comply	
			Cr(VI)	BL	---	Comply	
			PBBs	---	---	---	
			PBDEs	---	---	---	
50	Silvery metal sheet (on No.49)		Pb	BL	---	Comply	06 Jul 2012
			Cd	BL	---	Comply	
			Hg	BL	---	Comply	
			Cr(VI)	BL	---	Comply	
			PBBs	---	---	---	
			PBDEs	---	---	---	
51	Brown body w/ multicolor printing (in No.36)		Pb	BL	---	Comply	06 Jul 2012
			Cd	BL	---	Comply	
			Hg	BL	---	Comply	
			Cr(VI)	BL	---	Comply	
			PBBs	BL	---	Comply	
			PBDEs	BL	---	Comply	
52	Silvery metal pin (on No.51)		Pb	BL	---	Comply	06 Jul 2012
			Cd	BL	---	Comply	
			Hg	BL	---	Comply	
			Cr(VI)	BL	---	Comply	
			PBBs	---	---	---	
			PBDEs	---	---	---	

This document is issued by the Company subject to its General Conditions of Service printed overleaf, available on request or accessible at http://www.sgs.com/terms_and_conditions.htm and, for electronic format documents, subject to Terms and Conditions for Electronic Documents at www.sgs.com/terms_e-document.htm. Attention is drawn to the limitation of liability, indemnification and jurisdiction issues defined therein. Any holder of this document is advised that information contained hereon reflects the Company's findings at the time of its preparation only and within the limits of Client's instructions, if any. The Company's sole responsibility is to its Client and this document does not exonerate parties to a transaction from exercising all their rights and obligations under the transaction documents. This document cannot be reproduced except in full, without prior written approval of the Company. Any unauthorized alteration, forgery or falsification of the content or appearance of this document is unlawful and offenders may be prosecuted to the fullest extent of the law. Unless otherwise stated, the results shown in this test report refer only to the sample(s) tested.

Part No.	Part Description	BOM No.	Restricted Substances	Results of EDXRF (1)	Result of Wet Chemical Testing(2) (mg/kg)	Conclusion on RoHS	Sample Submitted / Resubmitted Date
53	Dk-grey core (L1 on No.13)		Pb Cd Hg Cr(VI) PBBs PBDEs	BL BL BL BL BL BL	--- --- --- --- --- ---	Comply Comply Comply Comply Comply Comply	06 Jul 2012
54	Copper-colored metal wire w/ transparent surface (on No.53)		Pb Cd Hg Cr(VI) PBBs PBDEs	BL BL BL BL BL BL	--- --- --- --- --- ---	Comply Comply Comply Comply Comply Comply	06 Jul 2012
55	Brown glue (on No.54)		Pb Cd Hg Cr(VI) PBBs PBDEs	BL BL BL BL BL BL	--- --- --- --- --- ---	Comply Comply Comply Comply Comply Comply	06 Jul 2012
56	Brown material sheet (in No.53)		Pb Cd Hg Cr(VI) PBBs PBDEs	BL BL BL BL BL BL	--- --- --- --- --- ---	Comply Comply Comply Comply Comply Comply	06 Jul 2012

This document is issued by the Company subject to its General Conditions of Service printed overleaf, available on request or accessible at http://www.sgs.com/terms_and_conditions.htm and, for electronic format documents, subject to Terms and Conditions for Electronic Documents at www.sgs.com/terms_e-document.htm. Attention is drawn to the limitation of liability, indemnification and jurisdiction issues defined therein. Any holder of this document is advised that information contained hereon reflects the Company's findings at the time of its preparation only and within the limits of Client's instructions, if any. The Company's sole responsibility is to its Client and this document does not exonerate parties to a transaction from exercising all their rights and obligations under the transaction documents. This document cannot be reproduced except in full, without prior written approval of the Company. Any unauthorized alteration, forgery or falsification of the content or appearance of this document is unlawful and offenders may be prosecuted to the fullest extent of the law. Unless otherwise stated, the results shown in this test report refer only to the sample(s) tested.

Part No.	Part Description	BOM No.	Restricted Substances	Results of EDXRF (1)	Result of Wet Chemical Testing(2) (mg/kg)	Conclusion on RoHS	Sample Submitted / Resubmitted Date
57	Green coating (on No.53)		Pb	BL	---	Comply	06 Jul 2012
			Cd	BL	---	Comply	
			Hg	BL	---	Comply	
			Cr(VI)	BL	---	Comply	
			PBBs	BL	---	Comply	
			PBDEs	BL	---	Comply	
58	Blue body w/ brown printing (C2 on No.13)		Pb	BL	---	Comply	06 Jul 2012
			Cd	BL	---	Comply	
			Hg	BL	---	Comply	
			Cr(VI)	BL	---	Comply	
			PBBs	BL	---	Comply	
			PBDEs	BL	---	Comply	
59	Black plastic w/ white printing (heat shrinkable tube) (CF1 on No.13)		Pb	BL	---	Comply	06 Jul 2012
			Cd	BL	---	Comply	
			Hg	BL	---	Comply	
			Cr(VI)	BL	---	Comply	
			PBBs	BL	---	Comply	
			PBDEs	BL	---	Comply	
60	Black body w/ silvery printing (D2 on No.13)		Pb	BL	---	Comply	06 Jul 2012
			Cd	BL	---	Comply	
			Hg	BL	---	Comply	
			Cr(VI)	BL	---	Comply	
			PBBs	IN	ND	Comply	
			PBDEs	IN	ND	Comply	

This document is issued by the Company subject to its General Conditions of Service printed overleaf, available on request or accessible at http://www.sgs.com/terms_and_conditions.htm and, for electronic format documents, subject to Terms and Conditions for Electronic Documents at www.sgs.com/terms_e-document.htm. Attention is drawn to the limitation of liability, indemnification and jurisdiction issues defined therein. Any holder of this document is advised that information contained hereon reflects the Company's findings at the time of its preparation only and within the limits of Client's instructions, if any. The Company's sole responsibility is to its Client and this document does not exonerate parties to a transaction from exercising all their rights and obligations under the transaction documents. This document cannot be reproduced except in full, without prior written approval of the Company. Any unauthorized alteration, forgery or falsification of the content or appearance of this document is unlawful and offenders may be prosecuted to the fullest extent of the law. Unless otherwise stated, the results shown in this test report refer only to the sample(s) tested.

Part No.	Part Description	BOM No.	Restricted Substances	Results of EDXRF (1)	Result of Wet Chemical Testing(2) (mg/kg)	Conclusion on RoHS	Sample Submitted / Resubmitted Date
61	Blue body w/ brown printing (C1 on No.13)		Pb	BL	---	Comply	06 Jul 2012
			Cd	BL	---	Comply	
			Hg	BL	---	Comply	
			Cr(VI)	BL	---	Comply	
			PBBs	IN	ND	Comply	
			PBDEs	IN	ND	Comply	
62	Brown body w/ multicolor printing (R1 on No.13)		Pb	BL	---	Comply	06 Jul 2012
			Cd	BL	---	Comply	
			Hg	BL	---	Comply	
			Cr(VI)	BL	---	Comply	
			PBBs	BL	---	Comply	
			PBDEs	BL	---	Comply	
63	Black body w/ silvery printing (D4 on No.13)		Pb	BL	---	Comply	06 Jul 2012
			Cd	BL	---	Comply	
			Hg	BL	---	Comply	
			Cr(VI)	BL	---	Comply	
			PBBs	IN	ND	Comply	
			PBDEs	IN	ND	Comply	
64	Blue body w/ brown printing (C9 on No.13)		Pb	BL	---	Comply	06 Jul 2012
			Cd	BL	---	Comply	
			Hg	BL	---	Comply	
			Cr(VI)	BL	---	Comply	
			PBBs	IN	ND	Comply	
			PBDEs	IN	ND	Comply	

This document is issued by the Company subject to its General Conditions of Service printed overleaf, available on request or accessible at http://www.sgs.com/terms_and_conditions.htm and, for electronic format documents, subject to Terms and Conditions for Electronic Documents at www.sgs.com/terms_e-document.htm. Attention is drawn to the limitation of liability, indemnification and jurisdiction issues defined therein. Any holder of this document is advised that information contained hereon reflects the Company's findings at the time of its preparation only and within the limits of Client's instructions, if any. The Company's sole responsibility is to its Client and this document does not exonerate parties to a transaction from exercising all their rights and obligations under the transaction documents. This document cannot be reproduced except in full, without prior written approval of the Company. Any unauthorized alteration, forgery or falsification of the content or appearance of this document is unlawful and offenders may be prosecuted to the fullest extent of the law. Unless otherwise stated, the results shown in this test report refer only to the sample(s) tested.

Part No.	Part Description	BOM No.	Restricted Substances	Results of EDXRF (1)	Result of Wet Chemical Testing(2) (mg/kg)	Conclusion on RoHS	Sample Submitted / Resubmitted Date
65	Yellow plastic w/ black printing (outer shell) (C10 on No.13)		Pb Cd Hg Cr(VI) PBBs PBDEs	BL BL BL BL BL BL	--- --- --- --- --- ---	Comply Comply Comply Comply Comply Comply	06 Jul 2012
66	Red/ black body (D6 on No.13)		Pb Cd Hg Cr(VI) PBBs PBDEs	OL▲ BL BL BL BL BL	--- --- --- --- --- ---	Comply Comply Comply Comply Comply Comply	06 Jul 2012
67	Red body w/ black printing (C12 on No.13)		Pb Cd Hg Cr(VI) PBBs PBDEs	BL BL BL BL BL BL	--- --- --- --- --- ---	Comply Comply Comply Comply Comply Comply	06 Jul 2012
68	Red body w/ black printing (C11 on No.13)		Pb Cd Hg Cr(VI) PBBs PBDEs	BL BL BL BL BL BL	--- --- --- --- --- ---	Comply Comply Comply Comply Comply Comply	06 Jul 2012

This document is issued by the Company subject to its General Conditions of Service printed overleaf, available on request or accessible at http://www.sgs.com/terms_and_conditions.htm and, for electronic format documents, subject to Terms and Conditions for Electronic Documents at www.sgs.com/terms_e-document.htm. Attention is drawn to the limitation of liability, indemnification and jurisdiction issues defined therein. Any holder of this document is advised that information contained hereon reflects the Company's findings at the time of its preparation only and within the limits of Client's instructions, if any. The Company's sole responsibility is to its Client and this document does not exonerate parties to a transaction from exercising all their rights and obligations under the transaction documents. This document cannot be reproduced except in full, without prior written approval of the Company. Any unauthorized alteration, forgery or falsification of the content or appearance of this document is unlawful and offenders may be prosecuted to the fullest extent of the law. Unless otherwise stated, the results shown in this test report refer only to the sample(s) tested.

Part No.	Part Description	BOM No.	Restricted Substances	Results of EDXRF (1)	Result of Wet Chemical Testing(2) (mg/kg)	Conclusion on RoHS	Sample Submitted / Resubmitted Date
69	Brown body w/ multicolor printing (R7 on No.13)		Pb	BL	---	Comply	06 Jul 2012
			Cd	BL	---	Comply	
			Hg	BL	---	Comply	
			Cr(VI)	BL	---	Comply	
			PBBs	BL	---	Comply	
			PBDEs	BL	---	Comply	
70	Red body w/ brown printing (C14 on No.13)		Pb	BL	---	Comply	06 Jul 2012
			Cd	BL	---	Comply	
			Hg	BL	---	Comply	
			Cr(VI)	BL	---	Comply	
			PBBs	BL	---	Comply	
			PBDEs	BL	---	Comply	
71	Blue body w/ multicolor printing (R9 on No.13)		Pb	BL	---	Comply	06 Jul 2012
			Cd	BL	---	Comply	
			Hg	BL	---	Comply	
			Cr(VI)	BL	---	Comply	
			PBBs	BL	---	Comply	
			PBDEs	BL	---	Comply	
72	Black body w/ brown printing (IC3 on No.13)		Pb	BL	---	Comply	06 Jul 2012
			Cd	BL	---	Comply	
			Hg	BL	---	Comply	
			Cr(VI)	BL	---	Comply	
			PBBs	IN	ND	Comply	
			PBDEs	IN	ND	Comply	

This document is issued by the Company subject to its General Conditions of Service printed overleaf, available on request or accessible at http://www.sgs.com/terms_and_conditions.htm and, for electronic format documents, subject to Terms and Conditions for Electronic Documents at www.sgs.com/terms_e-document.htm. Attention is drawn to the limitation of liability, indemnification and jurisdiction issues defined therein. Any holder of this document is advised that information contained hereon reflects the Company's findings at the time of its preparation only and within the limits of Client's instructions, if any. The Company's sole responsibility is to its Client and this document does not exonerate parties to a transaction from exercising all their rights and obligations under the transaction documents. This document cannot be reproduced except in full, without prior written approval of the Company. Any unauthorized alteration, forgery or falsification of the content or appearance of this document is unlawful and offenders may be prosecuted to the fullest extent of the law. Unless otherwise stated, the results shown in this test report refer only to the sample(s) tested.

Part No.	Part Description	BOM No.	Restricted Substances	Results of EDXRF (1)	Result of Wet Chemical Testing(2) (mg/kg)	Conclusion on RoHS	Sample Submitted / Resubmitted Date
73	Blue body w/ multicolor printing (R20 on No.13)		Pb	BL	---	Comply	06 Jul 2012
			Cd	BL	---	Comply	
			Hg	BL	---	Comply	
			Cr(VI)	BL	---	Comply	
			PBBs	BL	---	Comply	
			PBDEs	BL	---	Comply	
74	Black body w/ brown printing (IC2 on No.13)		Pb	BL	---	Comply	06 Jul 2012
			Cd	BL	---	Comply	
			Hg	BL	---	Comply	
			Cr(VI)	BL	---	Comply	
			PBBs	IN	ND	Comply	
			PBDEs	IN	ND	Comply	
75	Red body w/ black printing (C25 on No.13)		Pb	BL	---	Comply	06 Jul 2012
			Cd	BL	---	Comply	
			Hg	BL	---	Comply	
			Cr(VI)	BL	---	Comply	
			PBBs	BL	---	Comply	
			PBDEs	BL	---	Comply	
76 -C	Blue body w/ multicolor printing (R15 on No.13)		Pb	BL	---	Comply	06 Jul 2012 26 Jul 2012
			Cd	BL	---	Comply	
			Hg	BL	---	Comply	
			Cr(VI)	BL	---	Comply	
			PBBs	BL	---	Comply	
			PBDEs	BL	---	Comply	

This document is issued by the Company subject to its General Conditions of Service printed overleaf, available on request or accessible at http://www.sgs.com/terms_and_conditions.htm and, for electronic format documents, subject to Terms and Conditions for Electronic Documents at www.sgs.com/terms_e-document.htm. Attention is drawn to the limitation of liability, indemnification and jurisdiction issues defined therein. Any holder of this document is advised that information contained hereon reflects the Company's findings at the time of its preparation only and within the limits of Client's instructions, if any. The Company's sole responsibility is to its Client and this document does not exonerate parties to a transaction from exercising all their rights and obligations under the transaction documents. This document cannot be reproduced except in full, without prior written approval of the Company. Any unauthorized alteration, forgery or falsification of the content or appearance of this document is unlawful and offenders may be prosecuted to the fullest extent of the law. Unless otherwise stated, the results shown in this test report refer only to the sample(s) tested.

Part No.	Part Description	BOM No.	Restricted Substances	Results of EDXRF (1)	Result of Wet Chemical Testing(2) (mg/kg)	Conclusion on RoHS	Sample Submitted / Resubmitted Date
77	Green translucent body (LED) (D11 on No.13)		Pb Cd Hg Cr(VI) PBBs PBDEs	BL BL BL BL BL BL	--- --- --- --- --- ---	Comply Comply Comply Comply Comply Comply	06 Jul 2012
78	Black plastic w/ golden printing (outer shell) (C24 on No.13)		Pb Cd Hg Cr(VI) PBBs PBDEs	BL BL BL BL BL BL	--- --- --- --- --- ---	Comply Comply Comply Comply Comply Comply	06 Jul 2012
79 -C	Black plastic w/ white printing (heat shrinkable tube) (L2 on No.13)		Pb Cd Hg Cr(VI) PBBs PBDEs	BL BL BL BL BL BL	--- --- --- --- --- ---	Comply Comply Comply Comply Comply Comply	06 Jul 2012 26 Jul 2012
80	Dk-grey core (in No.79)		Pb Cd Hg Cr(VI) PBBs PBDEs	BL BL BL BL BL BL	--- --- --- --- --- ---	Comply Comply Comply Comply Comply Comply	06 Jul 2012

This document is issued by the Company subject to its General Conditions of Service printed overleaf, available on request or accessible at http://www.sgs.com/terms_and_conditions.htm and, for electronic format documents, subject to Terms and Conditions for Electronic Documents at www.sgs.com/terms_e-document.htm. Attention is drawn to the limitation of liability, indemnification and jurisdiction issues defined therein. Any holder of this document is advised that information contained hereon reflects the Company's findings at the time of its preparation only and within the limits of Client's instructions, if any. The Company's sole responsibility is to its Client and this document does not exonerate parties to a transaction from exercising all their rights and obligations under the transaction documents. This document cannot be reproduced except in full, without prior written approval of the Company. Any unauthorized alteration, forgery or falsification of the content or appearance of this document is unlawful and offenders may be prosecuted to the fullest extent of the law. Unless otherwise stated, the results shown in this test report refer only to the sample(s) tested.

Part No.	Part Description	BOM No.	Restricted Substances	Results of EDXRF (1)	Result of Wet Chemical Testing(2) (mg/kg)	Conclusion on RoHS	Sample Submitted / Resubmitted Date
81	Copper-colored metal wire w/ transparent surface (on No.80)		Pb Cd Hg Cr(VI) PBBs PBDEs	BL BL BL BL BL BL	--- --- --- --- --- ---	Comply Comply Comply Comply Comply Comply	06 Jul 2012
82	Dk-grey core (L3 on No.13)		Pb Cd Hg Cr(VI) PBBs PBDEs	BL BL BL BL BL BL	--- --- --- --- --- ---	Comply Comply Comply Comply Comply Comply	06 Jul 2012
83 -C	Green coating (on No.82)		Pb Cd Hg Cr(VI) PBBs PBDEs	BL BL BL BL BL BL	--- --- --- --- --- ---	Comply Comply Comply Comply Comply Comply	06 Jul 2012 26 Jul 2012
84	Red surfaced metal wire (ion No.82)		Pb Cd Hg Cr(VI) PBBs PBDEs	BL BL BL BL BL BL	--- --- --- --- --- ---	Comply Comply Comply Comply Comply Comply	06 Jul 2012

This document is issued by the Company subject to its General Conditions of Service printed overleaf, available on request or accessible at http://www.sgs.com/terms_and_conditions.htm and, for electronic format documents, subject to Terms and Conditions for Electronic Documents at www.sgs.com/terms_e-document.htm. Attention is drawn to the limitation of liability, indemnification and jurisdiction issues defined therein. Any holder of this document is advised that information contained hereon reflects the Company's findings at the time of its preparation only and within the limits of Client's instructions, if any. The Company's sole responsibility is to its Client and this document does not exonerate parties to a transaction from exercising all their rights and obligations under the transaction documents. This document cannot be reproduced except in full, without prior written approval of the Company. Any unauthorized alteration, forgery or falsification of the content or appearance of this document is unlawful and offenders may be prosecuted to the fullest extent of the law. Unless otherwise stated, the results shown in this test report refer only to the sample(s) tested.

Part No.	Part Description	BOM No.	Restricted Substances	Results of EDXRF (1)	Result of Wet Chemical Testing(2) (mg/kg)	Conclusion on RoHS	Sample Submitted / Resubmitted Date
85	Copper-colored metal wire w/ transparent surface (on No.82)		Pb Cd Hg Cr(VI) PBBs PBDEs	BL BL BL BL BL BL	--- --- --- --- --- ---	Comply Comply Comply Comply Comply Comply	06 Jul 2012
86	Silvery metal (solder) (on No.13)		Pb Cd Hg Cr(VI) PBBs PBDEs	BL BL BL BL --- ---	--- --- --- --- --- ---	Comply Comply Comply Comply --- ---	06 Jul 2012
87	Silvery metal part (in No.59)		Pb Cd Hg Cr(VI) PBBs PBDEs	BL BL BL BL --- ---	--- --- --- --- --- ---	Comply Comply Comply Comply --- ---	06 Jul 2012
88	Transparent glass tube (in No.59)		Pb Cd Hg Cr(VI) PBBs PBDEs	BL BL BL BL BL BL	--- --- --- --- --- ---	Comply Comply Comply Comply Comply Comply	06 Jul 2012

This document is issued by the Company subject to its General Conditions of Service printed overleaf, available on request or accessible at http://www.sgs.com/terms_and_conditions.htm and, for electronic format documents, subject to Terms and Conditions for Electronic Documents at www.sgs.com/terms_e-document.htm. Attention is drawn to the limitation of liability, indemnification and jurisdiction issues defined therein. Any holder of this document is advised that information contained hereon reflects the Company's findings at the time of its preparation only and within the limits of Client's instructions, if any. The Company's sole responsibility is to its Client and this document does not exonerate parties to a transaction from exercising all their rights and obligations under the transaction documents. This document cannot be reproduced except in full, without prior written approval of the Company. Any unauthorized alteration, forgery or falsification of the content or appearance of this document is unlawful and offenders may be prosecuted to the fullest extent of the law. Unless otherwise stated, the results shown in this test report refer only to the sample(s) tested.

Part No.	Part Description	BOM No.	Restricted Substances	Results of EDXRF (1)	Result of Wet Chemical Testing(2) (mg/kg)	Conclusion on RoHS	Sample Submitted / Resubmitted Date
89	Silvery metal pin (on No.87)		Pb Cd Hg Cr(VI) PBBs PBDEs	BL BL BL BL --- ---	--- --- --- --- --- ---	Comply Comply Comply Comply --- ---	06 Jul 2012
90	Silvery metal part (on No.88)		Pb Cd Hg Cr(VI) PBBs PBDEs	BL BL BL BL --- ---	--- --- --- --- --- ---	Comply Comply Comply Comply --- ---	06 Jul 2012
91	Grey metal wire (in No.88)		Pb Cd Hg Cr(VI) PBBs PBDEs	BL BL BL BL --- ---	--- --- --- --- --- ---	Comply Comply Comply Comply --- ---	06 Jul 2012
92	White fiber thread (in No.88)		Pb Cd Hg Cr(VI) PBBs PBDEs	BL BL BL BL BL BL	--- --- --- --- --- ---	Comply Comply Comply Comply Comply Comply	06 Jul 2012

This document is issued by the Company subject to its General Conditions of Service printed overleaf, available on request or accessible at http://www.sgs.com/terms_and_conditions.htm and, for electronic format documents, subject to Terms and Conditions for Electronic Documents at www.sgs.com/terms_e-document.htm. Attention is drawn to the limitation of liability, indemnification and jurisdiction issues defined therein. Any holder of this document is advised that information contained hereon reflects the Company's findings at the time of its preparation only and within the limits of Client's instructions, if any. The Company's sole responsibility is to its Client and this document does not exonerate parties to a transaction from exercising all their rights and obligations under the transaction documents. This document cannot be reproduced except in full, without prior written approval of the Company. Any unauthorized alteration, forgery or falsification of the content or appearance of this document is unlawful and offenders may be prosecuted to the fullest extent of the law. Unless otherwise stated, the results shown in this test report refer only to the sample(s) tested.

Part No.	Part Description	BOM No.	Restricted Substances	Results of EDXRF (1)	Result of Wet Chemical Testing(2) (mg/kg)	Conclusion on RoHS	Sample Submitted / Resubmitted Date
93	Grey metal pin (on No.13)		Pb	BL	---	Comply	06 Jul 2012
			Cd	BL	---	Comply	
			Hg	BL	---	Comply	
			Cr(VI)	BL	---	Comply	
			PBBs	---	---	---	
			PBDEs	---	---	---	

This document is issued by the Company subject to its General Conditions of Service printed overleaf, available on request or accessible at http://www.sgs.com/terms_and_conditions.htm and, for electronic format documents, subject to Terms and Conditions for Electronic Documents at www.sgs.com/terms_e-document.htm. Attention is drawn to the limitation of liability, indemnification and jurisdiction issues defined therein. Any holder of this document is advised that information contained hereon reflects the Company's findings at the time of its preparation only and within the limits of Client's instructions, if any. The Company's sole responsibility is to its Client and this document does not exonerate parties to a transaction from exercising all their rights and obligations under the transaction documents. This document cannot be reproduced except in full, without prior written approval of the Company. Any unauthorized alteration, forgery or falsification of the content or appearance of this document is unlawful and offenders may be prosecuted to the fullest extent of the law. Unless otherwise stated, the results shown in this test report refer only to the sample(s) tested.

Remark :

(1) (a) It is the result on total Br while test item on restricted substances is PBBs/PBDEs. It is the result on total Cr while test item on restricted substances is Cr(VI).

(b) Results are obtained by EDXRF for primary screening, and further chemical testing by ICP (for Cd, Pb, Hg), UV-VIS (for Cr(VI)) and GC/MS (for PBBs, PBDEs) is recommended to be performed, if the concentration exceeds the below warning value according to IEC62321(unit: mg/kg)

Element	Polymer	Metal	Composite Materials
Cd	$BL \leq (70-3\sigma) < X < (130+3\sigma) \leq OL$	$BL \leq (70-3\sigma) < X < (130+3\sigma) \leq OL$	$LOD < X < (150+3\sigma) \leq OL$
Pb	$BL \leq (700-3\sigma) < X < (1300+3\sigma) \leq OL$	$BL \leq (700-3\sigma) < X < (1300+3\sigma) \leq OL$	$BL \leq (500-3\sigma) < X < (1500+3\sigma) \leq OL$
Hg	$BL \leq (700-3\sigma) < X < (1300+3\sigma) \leq OL$	$BL \leq (700-3\sigma) < X < (1300+3\sigma) \leq OL$	$BL \leq (500-3\sigma) < X < (1500+3\sigma) \leq OL$
Br	$BL \leq (300-3\sigma) < X$	--	$BL \leq (250-3\sigma) < X$
Cr	$BL \leq (700-3\sigma) < X$	$BL \leq (700-3\sigma) < X$	$BL \leq (500-3\sigma) < X$

(c) BL = Below Limit, OL = Over Limit, IN = Inconclusive, LOD = Limit of Detection, -- = Not Regulated.

(d) The XRF screening test for RoHS elements - The reading may be different to the actual content in the sample be of non-uniformity composition.

(2) (a) mg/kg = ppm = 0.0001%, ND = Not Detected (<MDL), --- = Not Conducted, - = Without BOM.

(b) Unit and Method Detection Limit (MDL) in wet chemical test

Test Items	Pb	Cd	Hg
Units	mg/kg	mg/kg	mg/kg
MDL	2	2	2

The MDL for single compound of PBBs & PBDEs is 5 mg/kg and MDL of Cr(VI) for polymer & composite sample is 2 mg/kg.

* Due to the few amount of sample, MDL of Cr(VI) in Polymer and Composite Materials is 10 mg/kg.

(c) According to IEC 62321, result on Cr(VI) for metal sample is shown as Positive/Negative.
Negative = Absence of Cr(VI) coating, Positive = Presence of Cr(VI) coating.

- (d) ▲= According to the declaration from the client,
Lead (Pb) in No.49 is exempted by EU RoHS Directive 2011/65/EU based on: Copper alloy containing up to 4 % lead by weight.
Lead (Pb) in No.66 is exempted by EU RoHS Directive 2011/65/EU based on: Electrical and electronic components containing lead in a glass or ceramic other than dielectric ceramic in capacitors, e.g. piezoelectronic devices, or in a glass or ceramic matrix compound.

This document is issued by the Company subject to its General Conditions of Service printed overleaf, available on request or accessible at http://www.sgs.com/terms_and_conditions.htm and, for electronic format documents, subject to Terms and Conditions for Electronic Documents at www.sgs.com/terms_e-document.htm. Attention is drawn to the limitation of liability, indemnification and jurisdiction issues defined therein. Any holder of this document is advised that information contained hereon reflects the Company's findings at the time of its preparation only, and within the limits of Client's instructions, if any. The Company's sole responsibility is to its Client and this document does not exonerate parties to a transaction from exercising all their rights and obligations under the transaction documents. This document cannot be reproduced except in full, without prior written approval of the Company. Any unauthorized alteration, forgery or falsification of the content or appearance of this document is unlawful and offenders may be prosecuted to the fullest extent of the law. Unless otherwise stated, the results shown in this test report refer only to the sample(s) tested.

Sample photo:

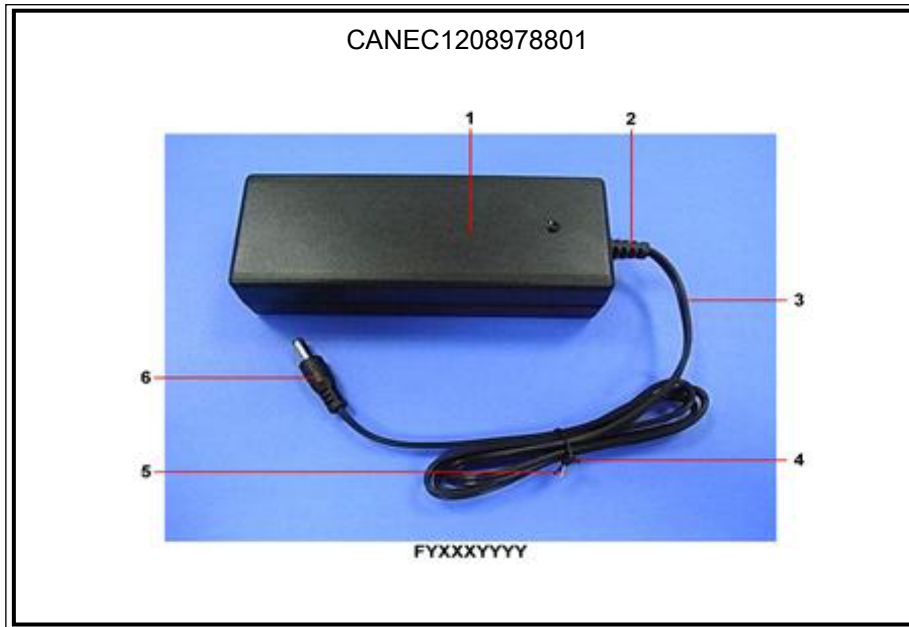

This document is issued by the Company subject to its General Conditions of Service printed overleaf, available on request or accessible at http://www.sgs.com/terms_and_conditions.htm and, for electronic format documents, subject to Terms and Conditions for Electronic Documents at www.sgs.com/terms_e-document.htm. Attention is drawn to the limitation of liability, indemnification and jurisdiction issues defined therein. Any holder of this document is advised that information contained hereon reflects the Company's findings at the time of its preparation only, and within the limits of Client's instructions, if any. The Company's sole responsibility is to its Client and this document does not exonerate parties to a transaction from exercising all their rights and obligations under the transaction documents. This document cannot be reproduced except in full, without prior written approval of the Company. Any unauthorized alteration, forgery or falsification of the content or appearance of this document is unlawful and offenders may be prosecuted to the fullest extent of the law.

Unless otherwise stated, the results shown in this test report refer only to the sample(s) tested.

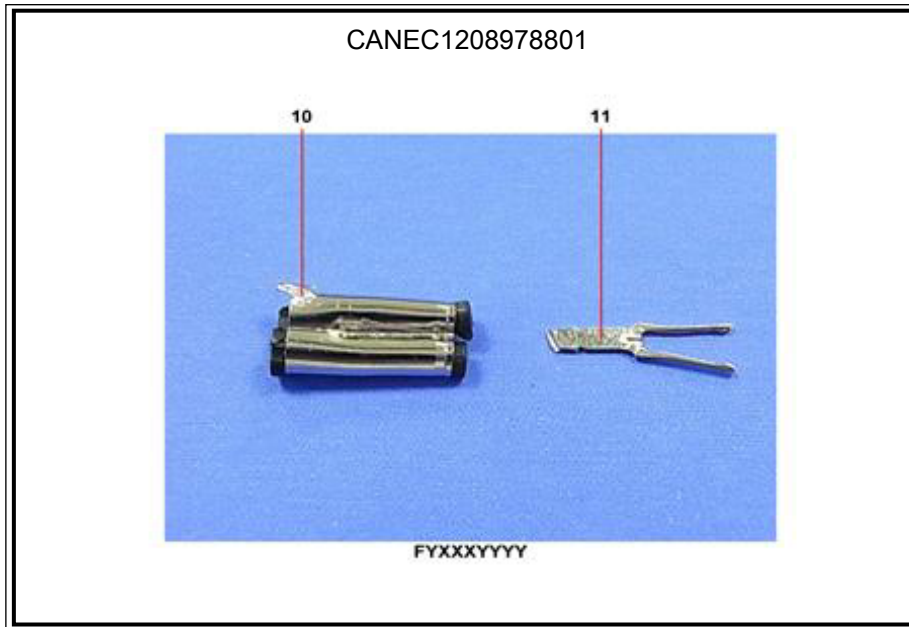
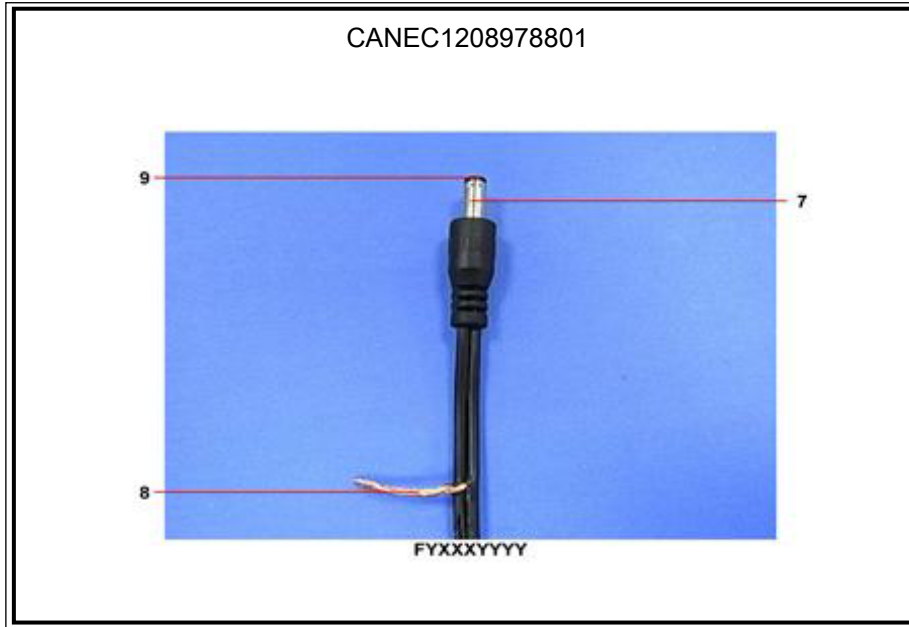

This document is issued by the Company subject to its General Conditions of Service printed overleaf, available on request or accessible at http://www.sgs.com/terms_and_conditions.htm and, for electronic format documents, subject to Terms and Conditions for Electronic Documents at www.sgs.com/terms_e-document.htm. Attention is drawn to the limitation of liability, indemnification and jurisdiction issues defined therein. Any holder of this document is advised that information contained hereon reflects the Company's findings at the time of its preparation only, and within the limits of Client's instructions, if any. The Company's sole responsibility is to its Client and this document does not exonerate parties to a transaction from exercising all their rights and obligations under the transaction documents. This document cannot be reproduced except in full, without prior written approval of the Company. Any unauthorized alteration, forgery or falsification of the content or appearance of this document is unlawful and offenders may be prosecuted to the fullest extent of the law.

Unless otherwise stated, the results shown in this test report refer only to the sample(s) tested.

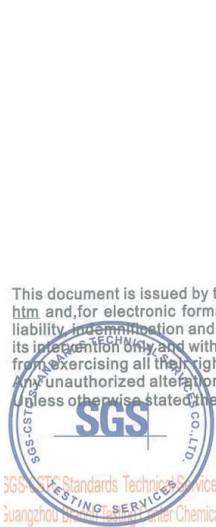

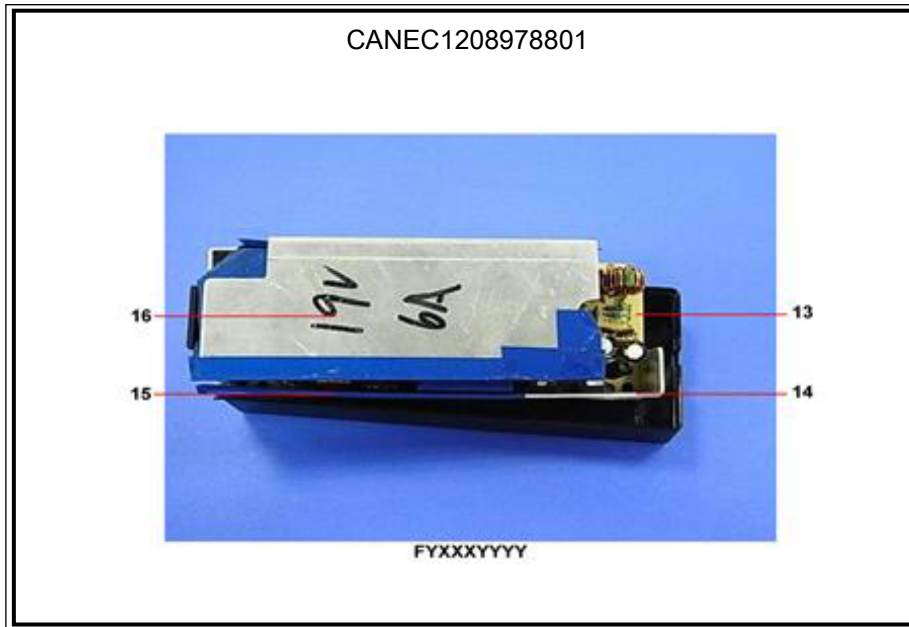

This document is issued by the Company subject to its General Conditions of Service printed overleaf, available on request or accessible at http://www.sgs.com/terms_and_conditions.htm and, for electronic format documents, subject to Terms and Conditions for Electronic Documents at www.sgs.com/terms_e-document.htm. Attention is drawn to the limitation of liability, indemnification and jurisdiction issues defined therein. Any holder of this document is advised that information contained hereon reflects the Company's findings at the time of its preparation only, and within the limits of Client's instructions, if any. The Company's sole responsibility is to its Client and this document does not exonerate parties to a transaction from exercising all their rights and obligations under the transaction documents. This document cannot be reproduced except in full, without prior written approval of the Company. Any unauthorized alteration, forgery or falsification of the content or appearance of this document is unlawful and offenders may be prosecuted to the fullest extent of the law. Unless otherwise stated, the results shown in this test report refer only to the sample(s) tested.

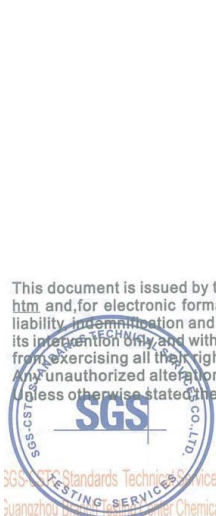

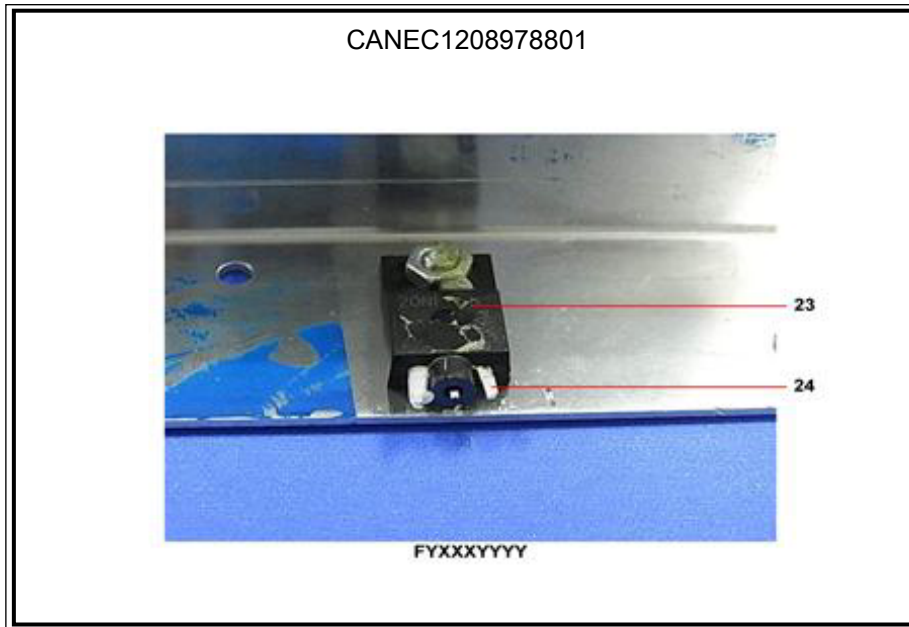
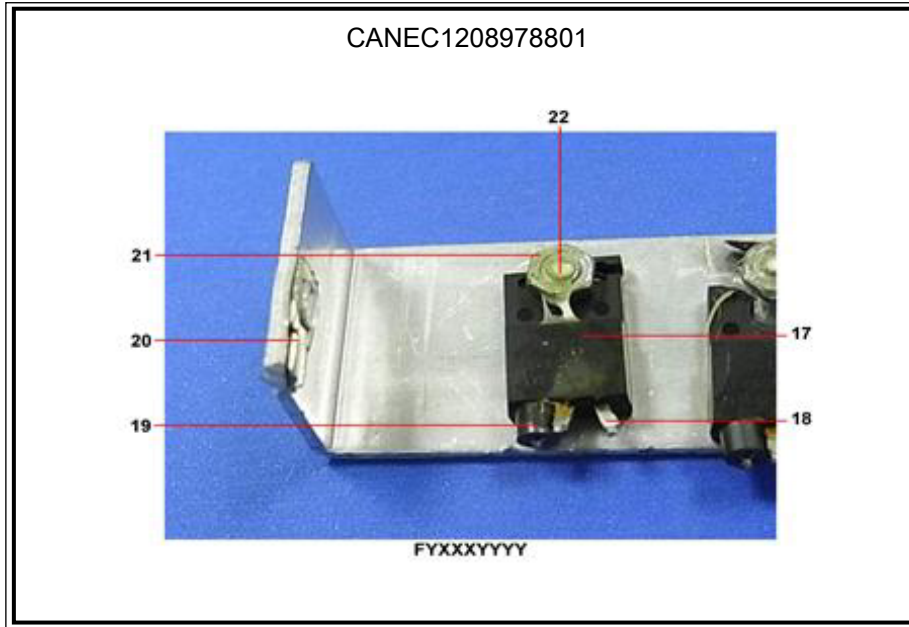

This document is issued by the Company subject to its General Conditions of Service printed overleaf, available on request or accessible at http://www.sgs.com/terms_and_conditions.htm and, for electronic format documents, subject to Terms and Conditions for Electronic Documents at www.sgs.com/terms_e-document.htm. Attention is drawn to the limitation of liability, indemnification and jurisdiction issues defined therein. Any holder of this document is advised that information contained hereon reflects the Company's findings at the time of its preparation only and within the limits of Client's instructions, if any. The Company's sole responsibility is to its Client and this document does not exonerate parties to a transaction from exercising all their rights and obligations under the transaction documents. This document cannot be reproduced except in full, without prior written approval of the Company. Any unauthorized alteration, forgery or falsification of the content or appearance of this document is unlawful and offenders may be prosecuted to the fullest extent of the law. Unless otherwise stated, the results shown in this test report refer only to the sample(s) tested.

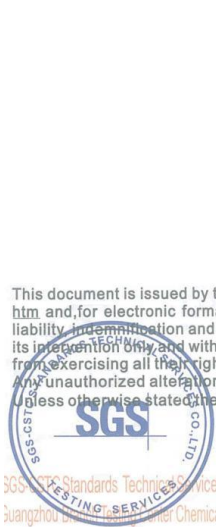

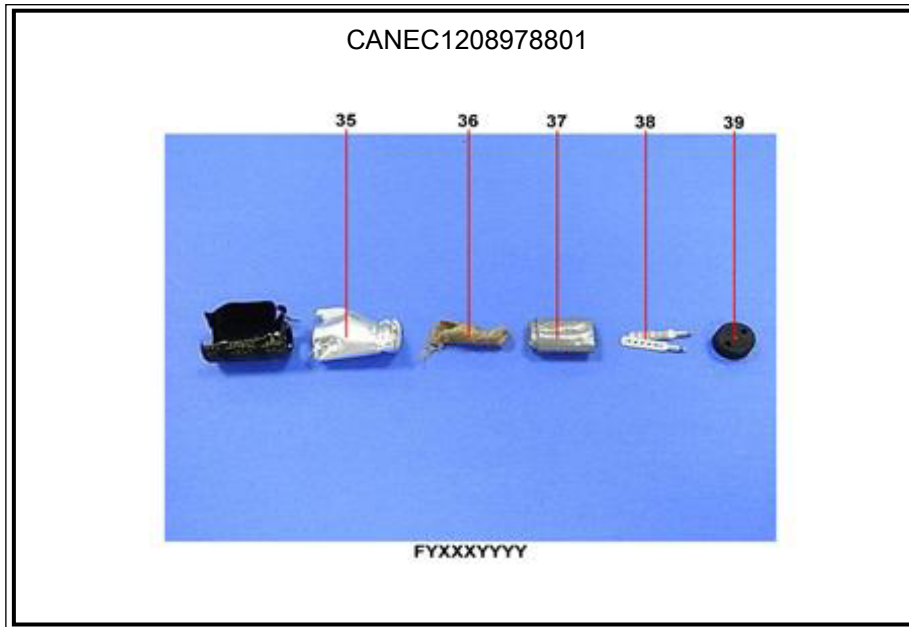
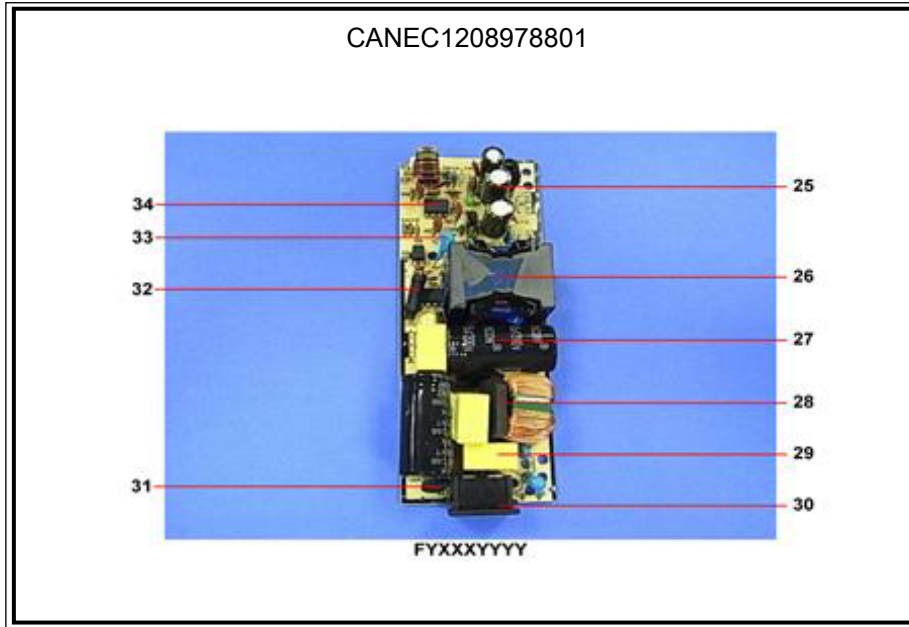

This document is issued by the Company subject to its General Conditions of Service printed overleaf, available on request or accessible at http://www.sgs.com/terms_and_conditions.htm and, for electronic format documents, subject to Terms and Conditions for Electronic Documents at www.sgs.com/terms_e-document.htm. Attention is drawn to the limitation of liability, indemnification and jurisdiction issues defined therein. Any holder of this document is advised that information contained hereon reflects the Company's findings at the time of its preparation only and within the limits of Client's instructions, if any. The Company's sole responsibility is to its Client and this document does not exonerate parties to a transaction from exercising all their rights and obligations under the transaction documents. This document cannot be reproduced except in full, without prior written approval of the Company. Any unauthorized alteration, forgery or falsification of the content or appearance of this document is unlawful and offenders may be prosecuted to the fullest extent of the law. Unless otherwise stated, the results shown in this test report refer only to the sample(s) tested.

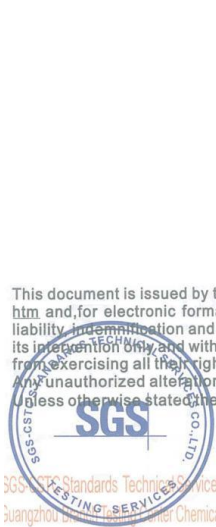

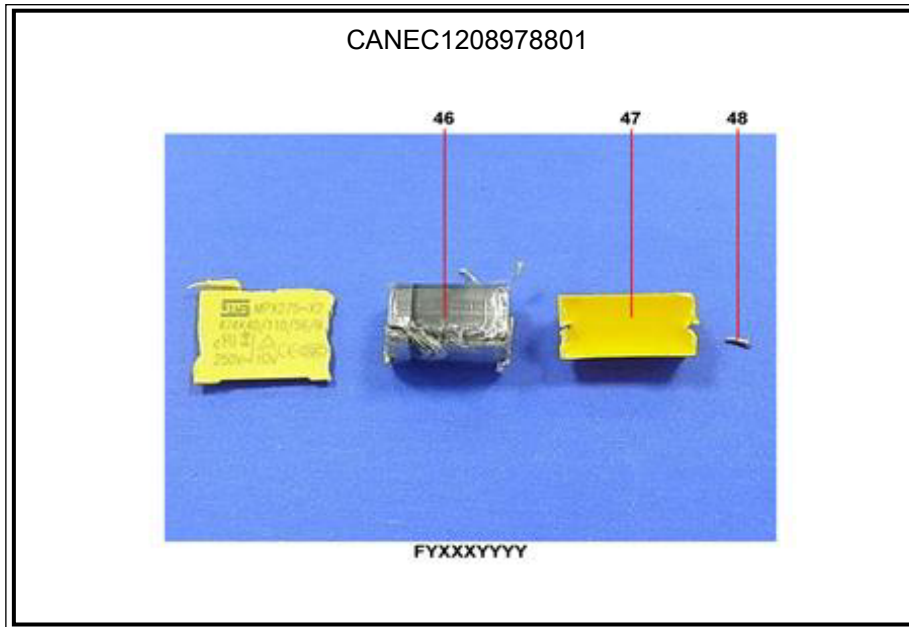
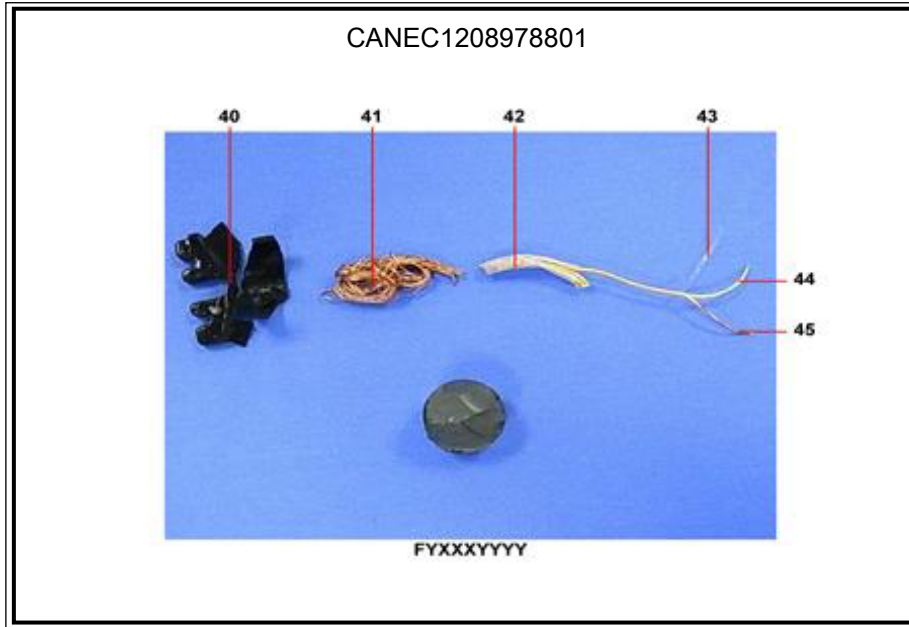

This document is issued by the Company subject to its General Conditions of Service printed overleaf, available on request or accessible at http://www.sgs.com/terms_and_conditions.htm and, for electronic format documents, subject to Terms and Conditions for Electronic Documents at www.sgs.com/terms_e-document.htm. Attention is drawn to the limitation of liability, indemnification and jurisdiction issues defined therein. Any holder of this document is advised that information contained hereon reflects the Company's findings at the time of its preparation only, and within the limits of Client's instructions, if any. The Company's sole responsibility is to its Client and this document does not exonerate parties to a transaction from exercising all their rights and obligations under the transaction documents. This document cannot be reproduced except in full, without prior written approval of the Company. Any unauthorized alteration, forgery or falsification of the content or appearance of this document is unlawful and offenders may be prosecuted to the fullest extent of the law.

Unless otherwise stated, the results shown in this test report refer only to the sample(s) tested.

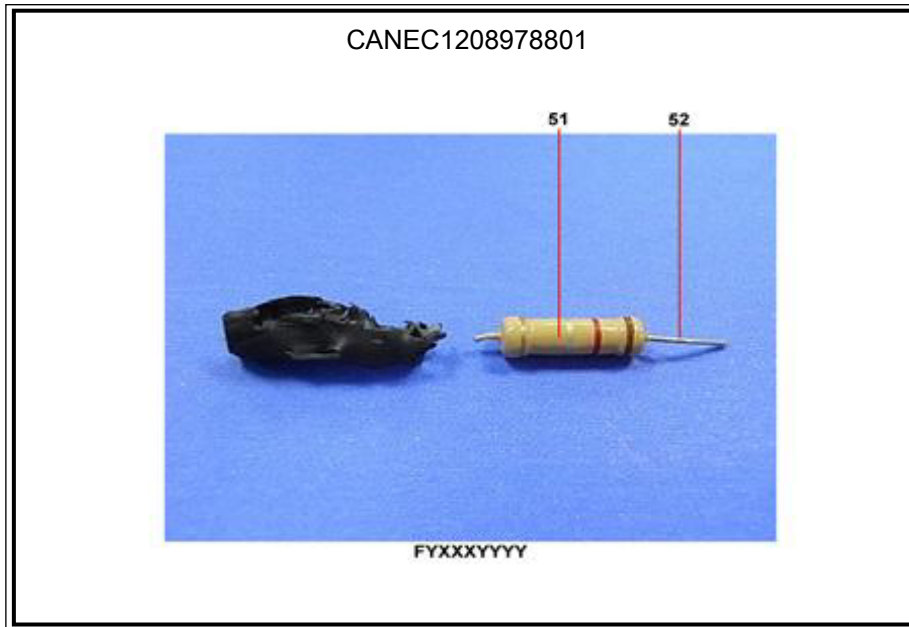
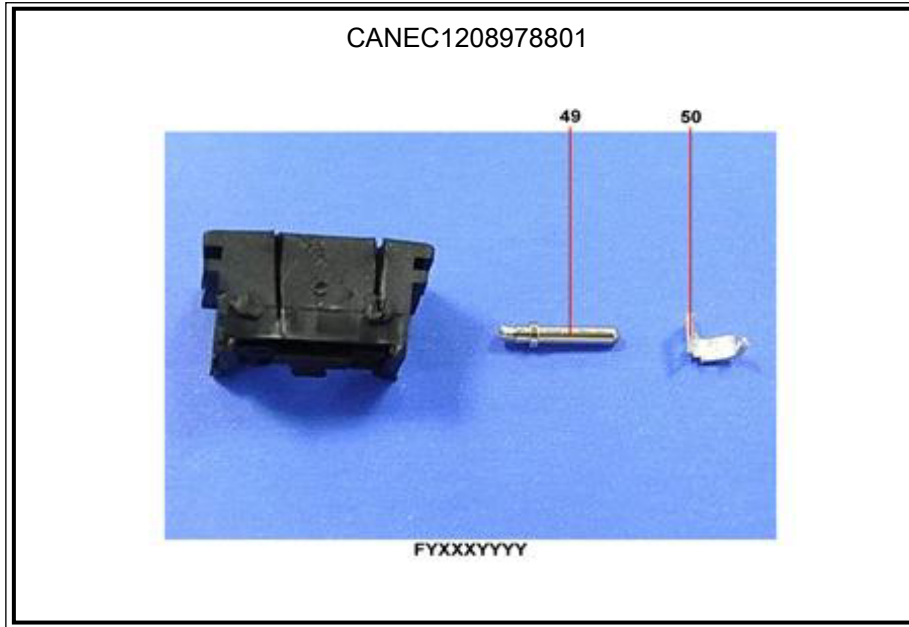

This document is issued by the Company subject to its General Conditions of Service printed overleaf, available on request or accessible at http://www.sgs.com/terms_and_conditions.htm and, for electronic format documents, subject to Terms and Conditions for Electronic Documents at www.sgs.com/terms_e-document.htm. Attention is drawn to the limitation of liability, indemnification and jurisdiction issues defined therein. Any holder of this document is advised that information contained hereon reflects the Company's findings at the time of its preparation only, and within the limits of Client's instructions, if any. The Company's sole responsibility is to its Client and this document does not exonerate parties to a transaction from exercising all their rights and obligations under the transaction documents. This document cannot be reproduced except in full, without prior written approval of the Company. Any unauthorized alteration, forgery or falsification of the content or appearance of this document is unlawful and offenders may be prosecuted to the fullest extent of the law. Unless otherwise stated, the results shown in this test report refer only to the sample(s) tested.

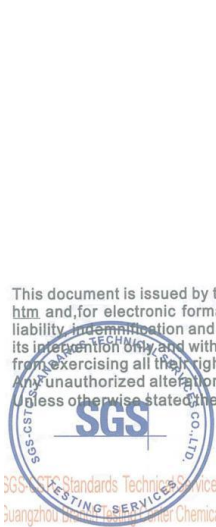

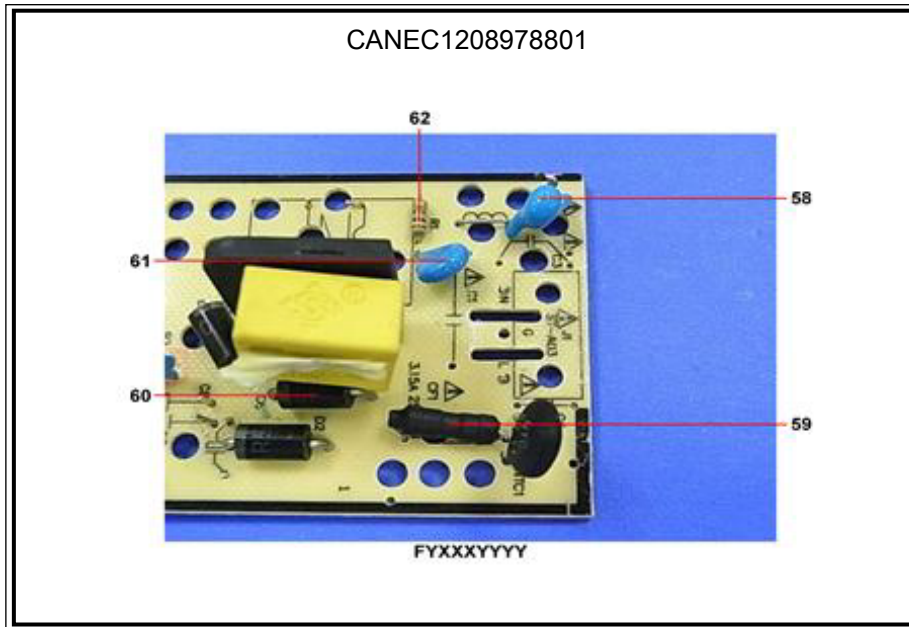
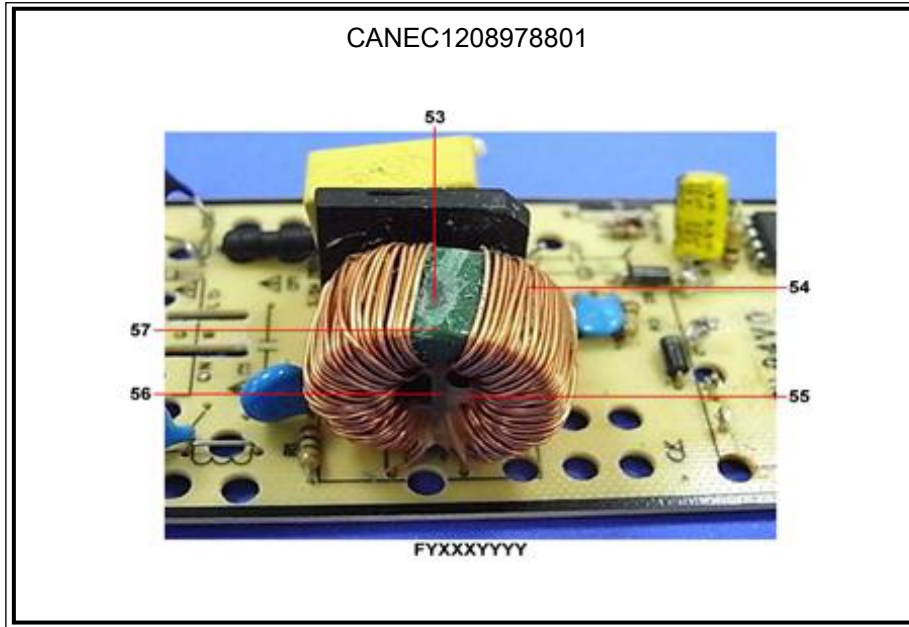

This document is issued by the Company subject to its General Conditions of Service printed overleaf, available on request or accessible at http://www.sgs.com/terms_and_conditions.htm and, for electronic format documents, subject to Terms and Conditions for Electronic Documents at www.sgs.com/terms_e-document.htm. Attention is drawn to the limitation of liability, indemnification and jurisdiction issues defined therein. Any holder of this document is advised that information contained hereon reflects the Company's findings at the time of its preparation only and within the limits of Client's instructions, if any. The Company's sole responsibility is to its Client and this document does not exonerate parties to a transaction from exercising all their rights and obligations under the transaction documents. This document cannot be reproduced except in full, without prior written approval of the Company. Any unauthorized alteration, forgery or falsification of the content or appearance of this document is unlawful and offenders may be prosecuted to the fullest extent of the law. Unless otherwise stated, the results shown in this test report refer only to the sample(s) tested.

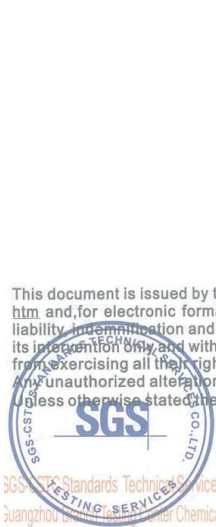

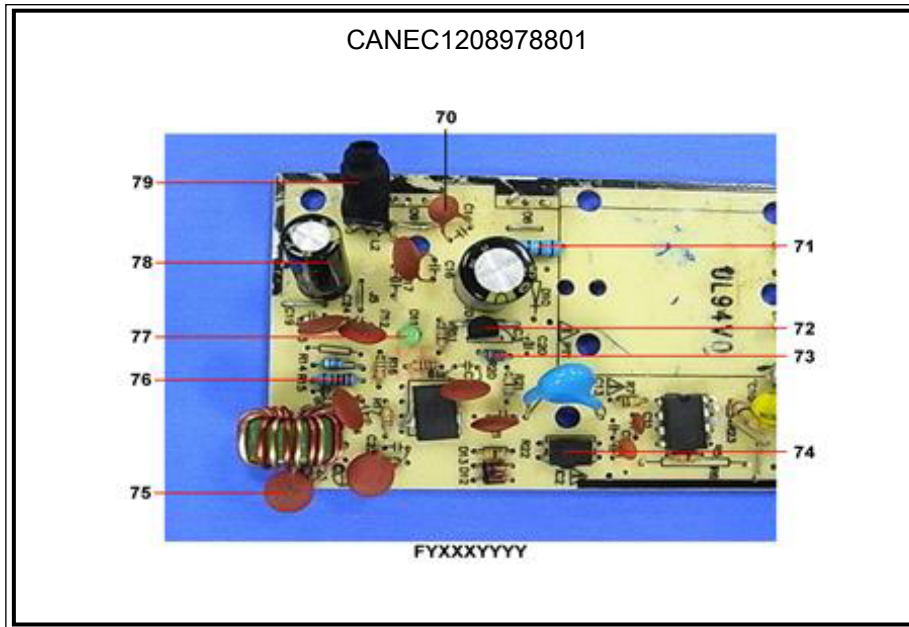
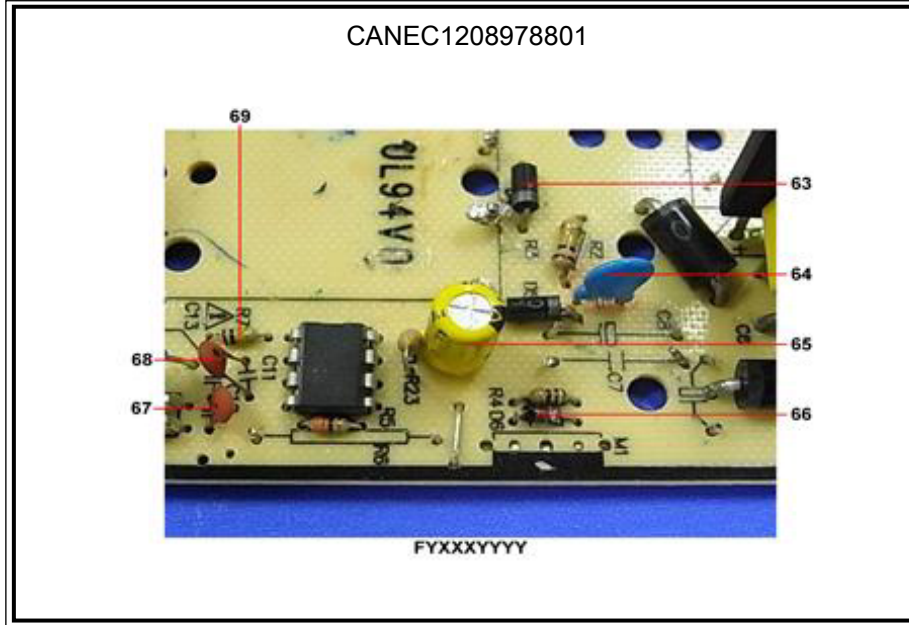

This document is issued by the Company subject to its General Conditions of Service printed overleaf, available on request or accessible at http://www.sgs.com/terms_and_conditions.htm and, for electronic format documents, subject to Terms and Conditions for Electronic Documents at www.sgs.com/terms_e-document.htm. Attention is drawn to the limitation of liability, indemnification and jurisdiction issues defined therein. Any holder of this document is advised that information contained hereon reflects the Company's findings at the time of its preparation only and within the limits of Client's instructions, if any. The Company's sole responsibility is to its Client and this document does not exonerate parties to a transaction from exercising all their rights and obligations under the transaction documents. This document cannot be reproduced except in full, without prior written approval of the Company. Any unauthorized alteration, forgery or falsification of the content or appearance of this document is unlawful and offenders may be prosecuted to the fullest extent of the law. Unless otherwise stated, the results shown in this test report refer only to the sample(s) tested.

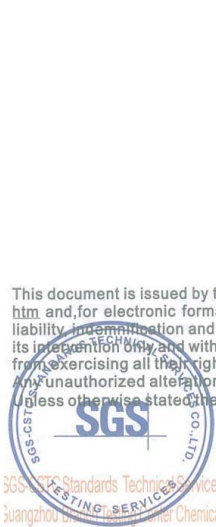

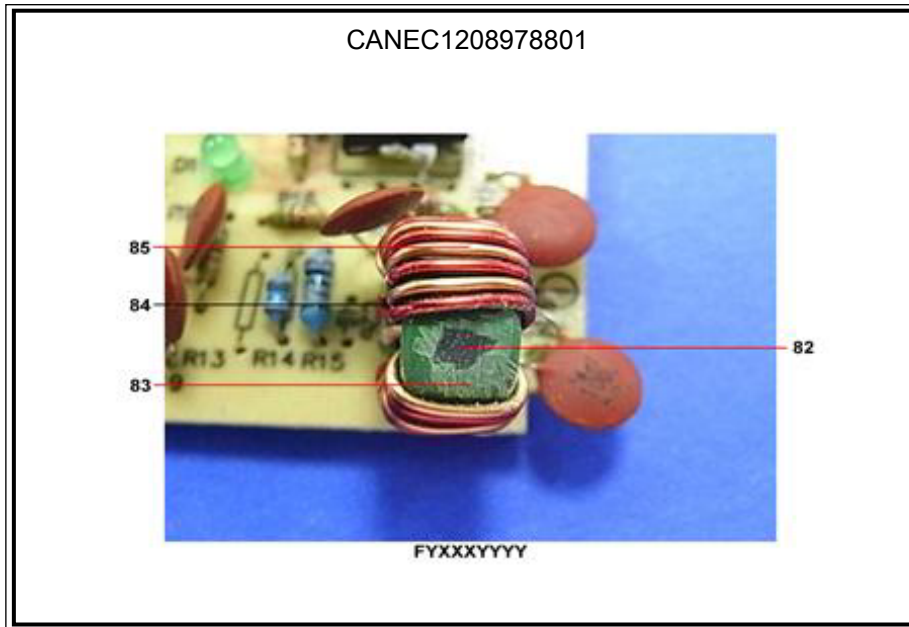
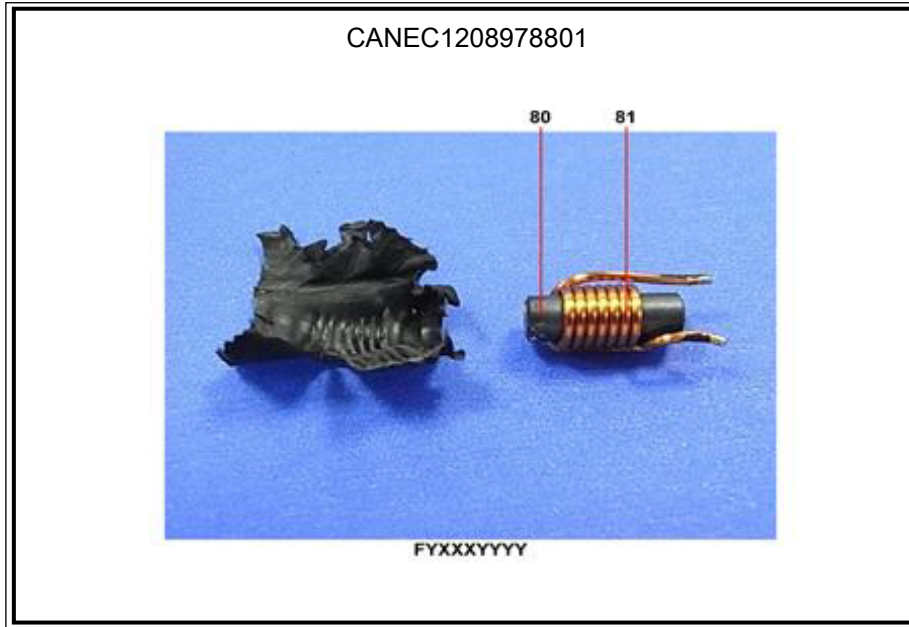

This document is issued by the Company subject to its General Conditions of Service printed overleaf, available on request or accessible at http://www.sgs.com/terms_and_conditions.htm and, for electronic format documents, subject to Terms and Conditions for Electronic Documents at www.sgs.com/terms_e-document.htm. Attention is drawn to the limitation of liability, indemnification and jurisdiction issues defined therein. Any holder of this document is advised that information contained hereon reflects the Company's findings at the time of its preparation only, and within the limits of Client's instructions, if any. The Company's sole responsibility is to its Client and this document does not exonerate parties to a transaction from exercising all their rights and obligations under the transaction documents. This document cannot be reproduced except in full, without prior written approval of the Company. Any unauthorized alteration, forgery or falsification of the content or appearance of this document is unlawful and offenders may be prosecuted to the fullest extent of the law. Unless otherwise stated, the results shown in this test report refer only to the sample(s) tested.

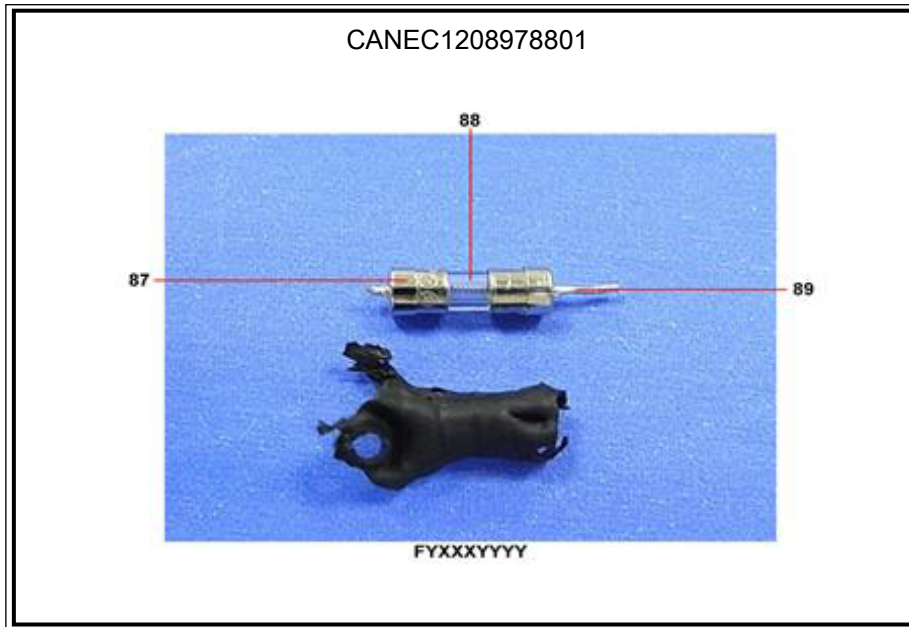
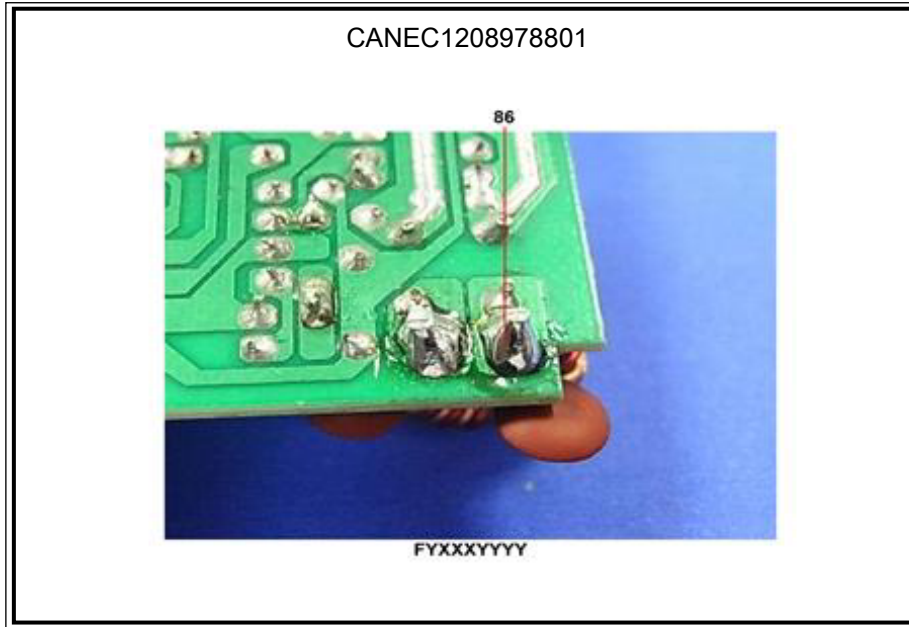

This document is issued by the Company subject to its General Conditions of Service printed overleaf, available on request or accessible at http://www.sgs.com/terms_and_conditions.htm and, for electronic format documents, subject to Terms and Conditions for Electronic Documents at www.sgs.com/terms_e-document.htm. Attention is drawn to the limitation of liability, indemnification and jurisdiction issues defined therein. Any holder of this document is advised that information contained hereon reflects the Company's findings at the time of its preparation only, and within the limits of Client's instructions, if any. The Company's sole responsibility is to its Client and this document does not exonerate parties to a transaction from exercising all their rights and obligations under the transaction documents. This document cannot be reproduced except in full, without prior written approval of the Company. Any unauthorized alteration, forgery or falsification of the content or appearance of this document is unlawful and offenders may be prosecuted to the fullest extent of the law. Unless otherwise stated, the results shown in this test report refer only to the sample(s) tested.

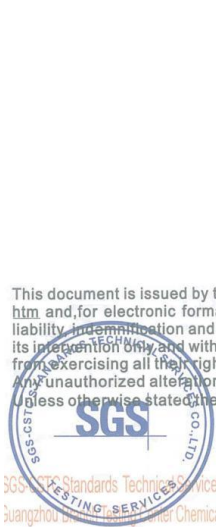

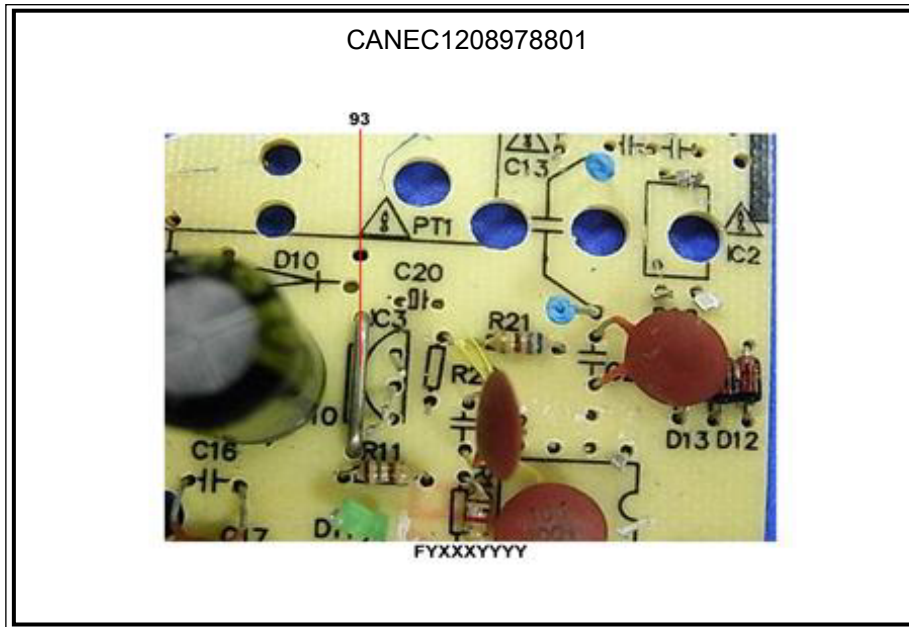
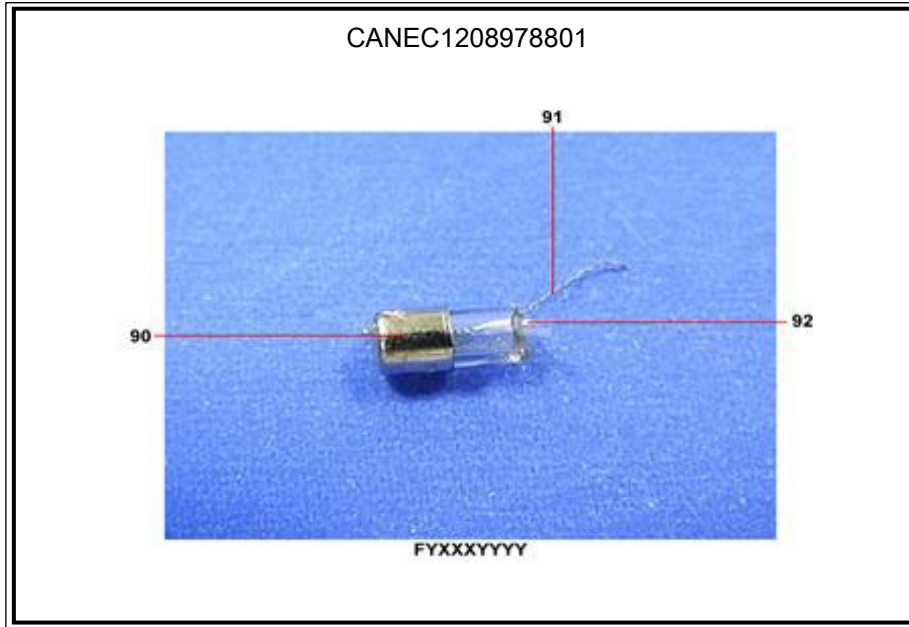

SGS authenticate the photo on original report only

*** End of Report ***

This document is issued by the Company subject to its General Conditions of Service printed overleaf, available on request or accessible at http://www.sgs.com/terms_and_conditions.htm and, for electronic format documents, subject to Terms and Conditions for Electronic Documents at www.sgs.com/terms_e-document.htm. Attention is drawn to the limitation of liability, indemnification and jurisdiction issues defined therein. Any holder of this document is advised that information contained hereon reflects the Company's findings at the time of its preparation only and within the limits of Client's instructions, if any. The Company's sole responsibility is to its Client and this document does not exonerate parties to a transaction from exercising all their rights and obligations under the transaction documents. This document cannot be reproduced except in full, without prior written approval of the Company. Any unauthorized alteration, forgery or falsification of the content or appearance of this document is unlawful and offenders may be prosecuted to the fullest extent of the law. Unless otherwise stated, the results shown in this test report refer only to the sample(s) tested.